

**5510, 5513
(STRIKE AND KEEPER - INSWING/OUTSWING 1-1/4")**

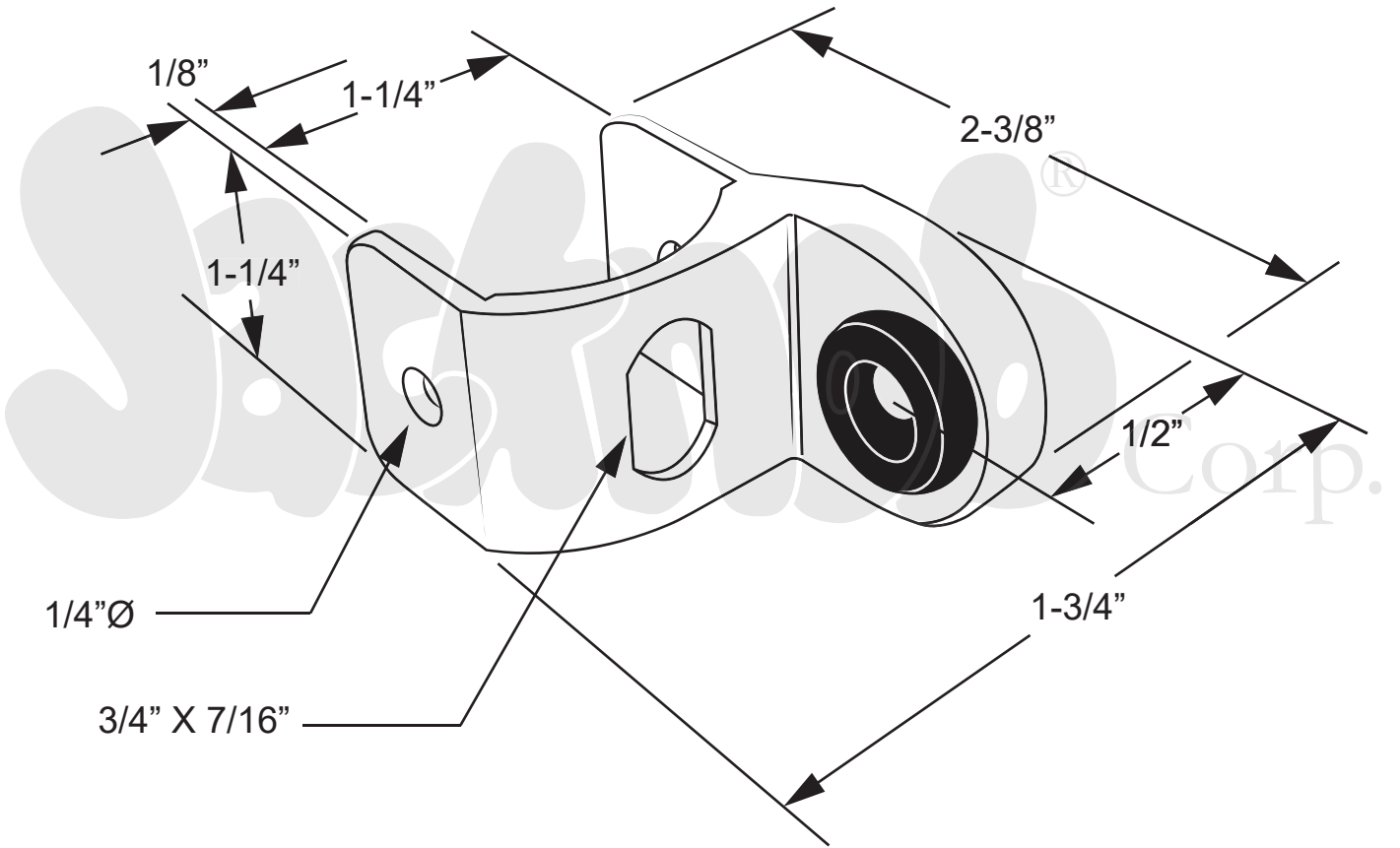

Copyright - 2023 Jacknob Corp. All rights reserved

All dimensions shown are approximate. Do not pre-drill or fabricate based on dimensions shown.

The manufacturer reserves the right to, and may from time to time, make changes in dimensions and designs.