



SINCE 1981  
**WIELHOUSER**

REPLACEMENT HARDWARE SPECIALISTS

Supplier of Aftermarket Parts to Public and Private Facilities

# Replacement HARDWARE CATALOGUE

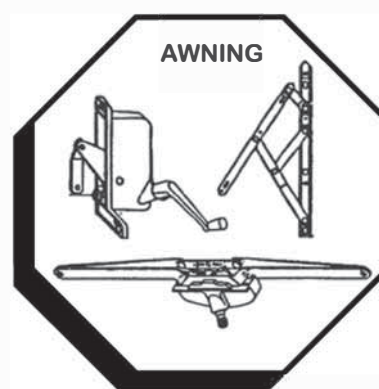

Toilet Partition Parts • Locker Parts • Chair Glides  
Door and Window Hardware • Security Mirrors  
Washroom & Handicapped Accessories  
Gym / Folding Door Repair & Maintenance  
Door Closer Repair & Exchange Service

Monday to Friday  
8:00 am - 5:00 pm (EST)

**1-800-465-2815**

Email: [info@replacementhardware.ca](mailto:info@replacementhardware.ca)

Website: [www.replacementhardware.ca](http://www.replacementhardware.ca)

Phone: (519) 633-0998 • Fax: (519) 631-2282

## Company Profile:

Supplier of toilet partition parts, locker parts, door and window hardware, security mirrors, hospital supplies, and a 30 year history of diagnosing and repairing dividing gym doors. Door closer rebuild service of all makes as well as floor/header closers. Wielhouwer Inc. was founded in 1981 but has had the expertise since 1967 with regard to new and obsolete hardware. Our clients are school boards, universities, colleges, municipalities, industry suppliers etc.

## Table of Contents

- 1 ..... Door Closer Repair & Exchange Service
- 2 ..... Gym Door Repair & Maintenance
- 3 ..... General Storage Systems Distributor (Partitions & Lockers)
- 4 ..... Toilet Partition Hardware Diagram
- 5 ..... Toilet Partition Hardware: Watrous & Stainless Steel
- 6 ..... Toilet Partition Hardware: Latches, door handles, coat hooks & door stops
- 7 ..... Toilet Partition Hardware: Universal hinge sets, full length surface hinges, surface mounted hinge sets
- 8 ..... Toilet Partition Hardware: Strikes & keepers
- 9 ..... Toilet Partition Hardware: Ampco, Hadrian
- 10 ..... Toilet Partition Hardware: Comtec, Capital, Hiny Hiders, Fiat
- 11 ..... Toilet Partition Hardware: Flush Metal, General
- 12 ..... Toilet Partition Hardware: Accurate, Hardware Fasteners.
- 13 ..... Toilet Partition Hardware: Sanymetal
- 14 ..... Toilet Partition Hardware: Global, Bobrick
- 15 ..... Toilet Partition Hardware: Knickerbocker, Metpar
- 16 ..... Toilet Partition Hardware: Metpar, Mills
- 17 ..... Toilet Partition Hardware: GSS, Fleming
- 18 ..... Toilet Partition Hardware: Brackets, Anchors, and Shoes
- 19 ..... Toilet Partition Hardware: Shanahan's
- 20 ..... Fix-It Kits
- 21 ..... Grab Bars for Toilet Stools, Showers, and Urinals
- 22 ..... Frost Dispensers & Washroom Accessories
- 23 ..... Frost Safety Coat Hooks, SS Hat & Coat Racks, and SS Towel Bars.
- 24 ..... Dome & Convex Safety Mirrors
- 25 ..... Pemko Door Hardware & Accessories
- 26 ..... Door & Locker Hardware
- 27 ..... Door Stops, Holders & Wall Stops
- 28 ..... Window Hardware: Channel Balances
- 29 ..... Window Hardware: Tube Balances
- 30 ..... Window Hardware: Caldwell Tape Balances
- 31 ..... Window Hardware: 4 Bar Hinges & Handle Info
- 32 ..... Window Hardware: Push Bars
- 33 ..... Window Hardware: Roto Operator Assemblies

**If you don't see your part, please email us a photo.**

- 34 ..... Window Hardware: Truth Operators
- 35 ..... Window Hardware: Truth Pushbars, Cam Locks, Hinges, etc.
- 36 ..... Window Hardware: Project-In and Angle Base Handles
- 37 ..... Window Hardware: Two Hole Cam Handles
- 38 ..... Casters
- 49 ..... Glides

If you don't see your part, please email us a photo.

# Door Closer Arms

RUSSWIN/CORBIN — 100/110/2800/2810

REGULAR ARM

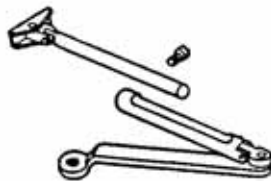

PART NO. 28R100

HOLD OPEN ARM



PART NO. 28H100

## Door Closer

# REPAIR SERVICE

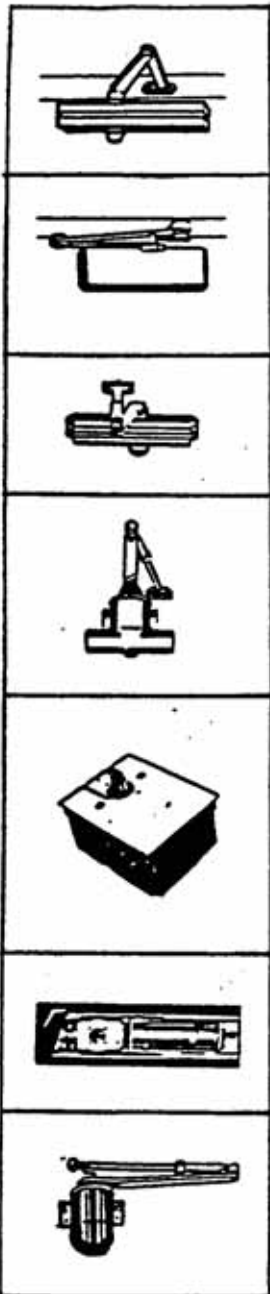

HAVE US REBUILD YOUR DOOR CLOSER FOR

# \$69.00

ONE YEAR WARRANTY.

NEW SEALS, HYDRAULIC OIL, AND SPRAYED.

ALL MAJOR PARTS EXTRA

## ALL TYPES AND MAKES

LCN (ALL SERIES), NORTON, DOROMATIC, PITCO, RICHARD WILCOX, BRITTON, CORBIN, RUSWIN, KAWNEER, ALUMICOR, COMMERCIAL ALUMINUM, P.P.G., ZIMCOR, AND MANY OTHERS.

NOTE: FLOOR MOUNTS AND HEADER CLOSERS ARE NOT QUOTED UNDER THIS PRICE. WE DO NOT REPAIR ELECTRONIC DOOR CLOSERS.

WE HAVE REORGANIZED OUR SHOP FOR FASTER SERVICE. GUARANTEE 2 WEEKS DELIVERY UPON RECEIPT OF CLOSER.

# ***FOLDING PANEL DOORS***

**"We have the expertise to repair and maintain your folding doors"**

## ***ALL TYPES:***

- Gymnasium
- Classroom
- Cafeteria

## ***ALL MAKES:***

- Modern Fold
- Jorgensen  
(Hauserman Can.  
Ltd.)
- Richard-Wilcox
- Any other make

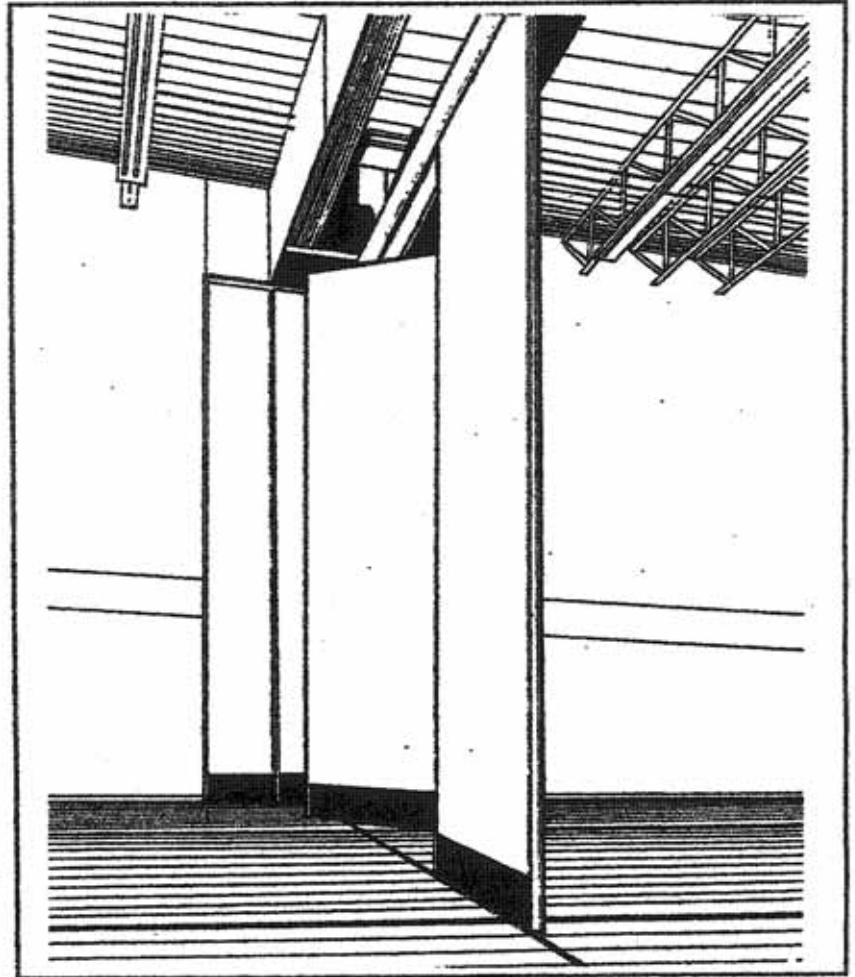

***LET US QUOTE  
ON YOUR REQUIREMENTS  
OR SUPPLY PARTS ONLY***

# GSS

## CANADIAN STALL

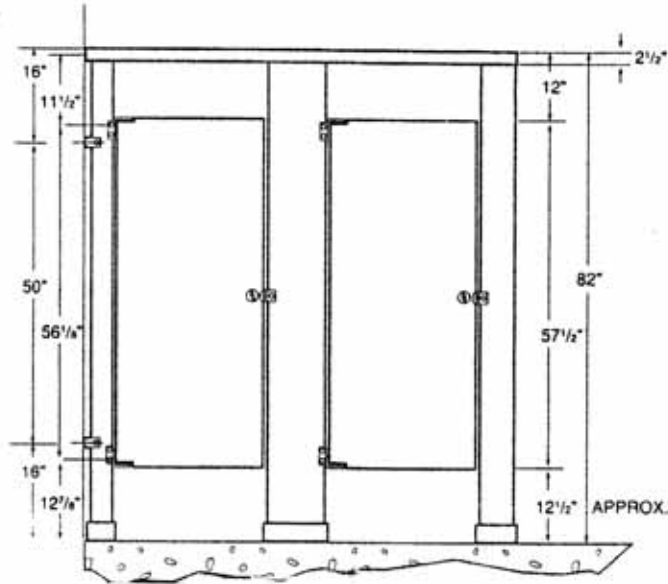

## DISTRIBUTOR

Made by General Storage Systems

CALL 1-800-465-2815 OR  
FAX 1-519-631-2282 FOR  
PRICES, SIZES AND  
COLOUR CHART.

## REPLACEMENT METAL TOILET DOORS AND HDW KITS ALSO AVAILABLE FOR:

HADRIAN, SHANAHAN  
Global  
AMPCO, WATROUS & BOBRICK

## CANADIAN LOCKER

### INTERIOR EQUIPMENT

the Single-Tier locker shall have a shelf located approximately 14" (356 mm) below the top. The Single-Tier, Double-Tier and Triple-Tier locker compartments shall have 3 zinc-plated round tipped metal coat hooks, attached with 2 bolts or pop rivets per hook.

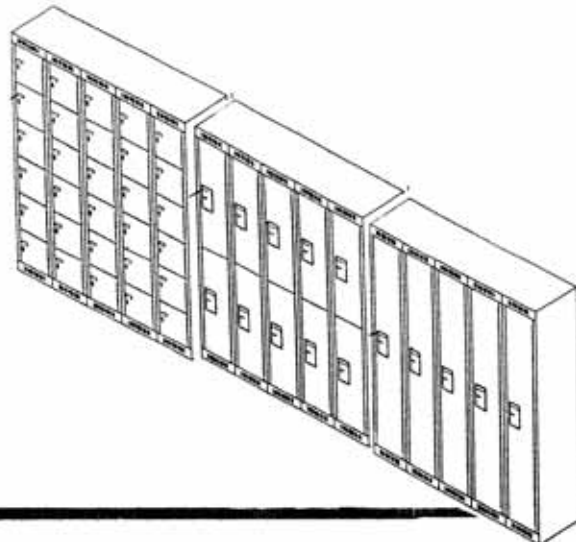

# WIELHOUWER & ASSOCIATES

*New and Replacement Hardware*

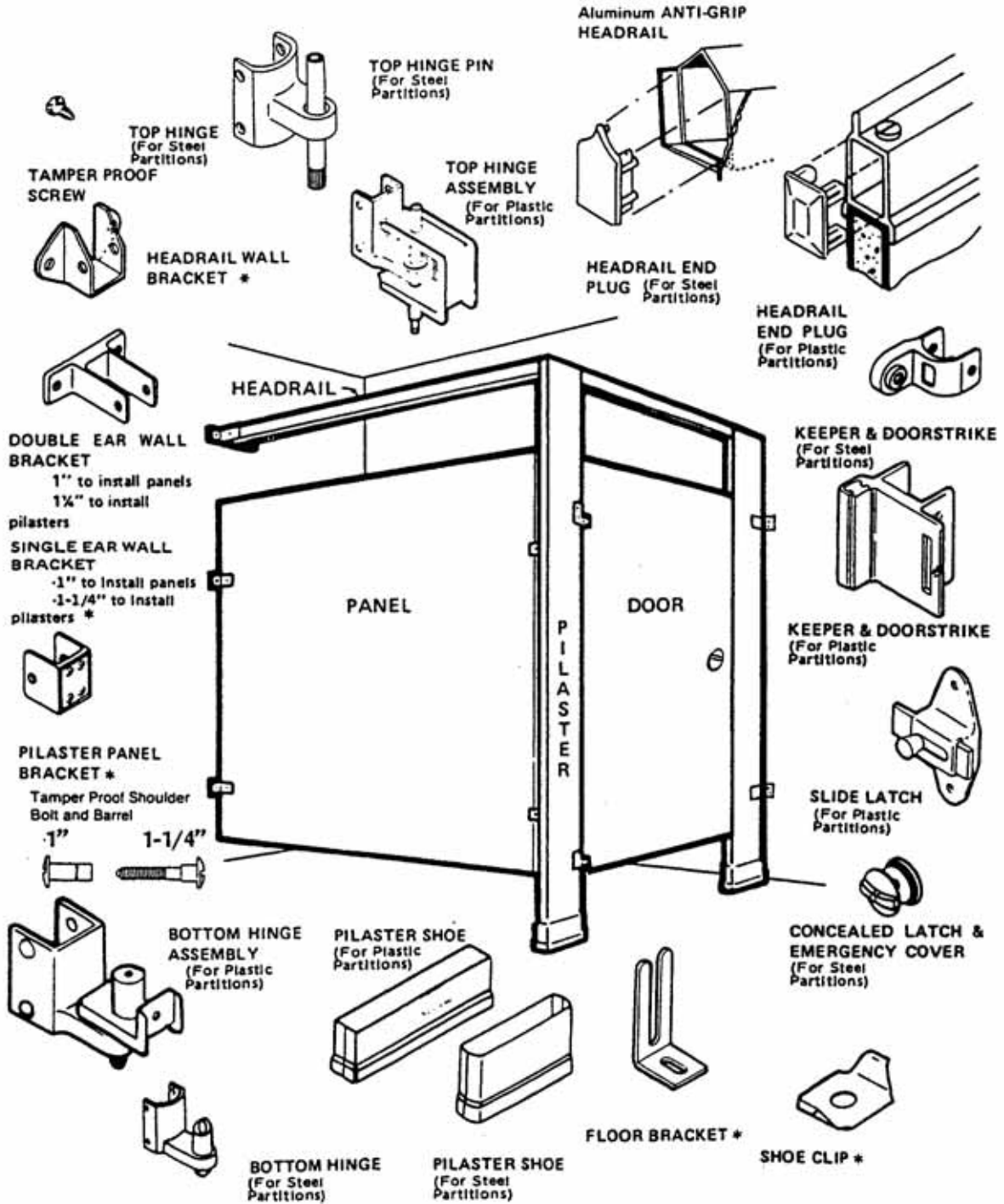

FOR MORE INFORMATION CALL TOLL FREE

1 - 8 0 0 - 4 6 5 - 2 8 1 5

# Toilet Partition Hardware

## WATROUS

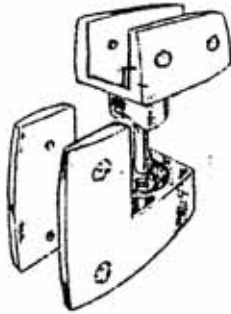

LOWER HINGE  
#9W2223

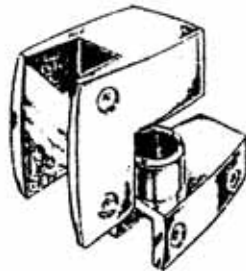

UPPER HINGE  
#9W1921

Current  
LATCH

#9W2000



Current  
OUTSWING  
KEEPER BUMPER

#9W2400-OUT

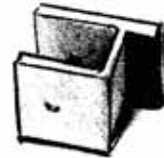

Current  
INSWING  
KEEPER BUMPER

#9W2400-IN

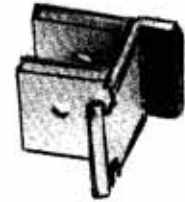

## STAINLESS STEEL

57-1/2" STAINLESS STEEL  
CONTINUOUS PIANO  
HINGES

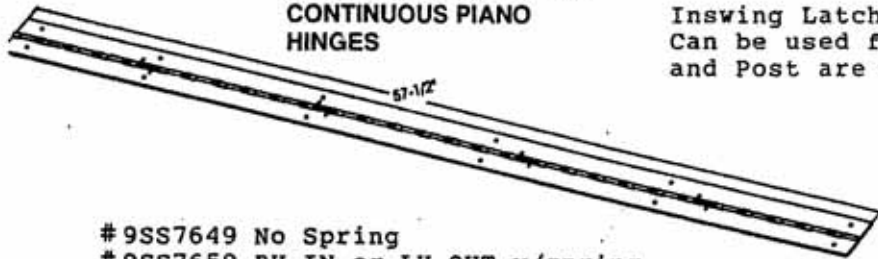

Inswing Latch and Strike Combo  
Can be used for Outswing if Door  
and Post are Equal

- #9SS7649 No Spring
- #9SS7659 RH-IN or LH-OUT w/spring
- #9SS7669 LH-IN or RH-OUT w/spring

#9SS6409

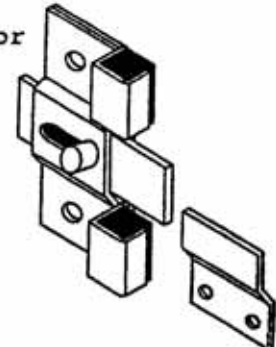

#9SS6539 Keeper for # 6409

BUMPER  
#9SS6329

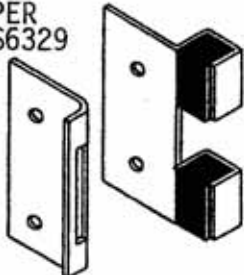

#9SS6319 KEEPER

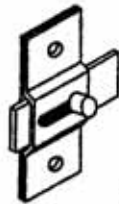

#9SS6309 Slide Latch

#9SS6469

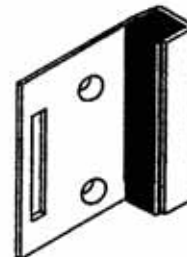
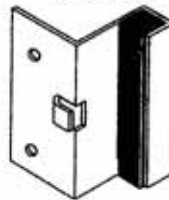

#9SS5149 Inswing

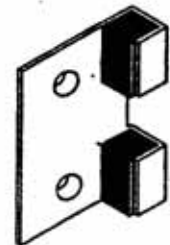

#9SS5269 Outswing

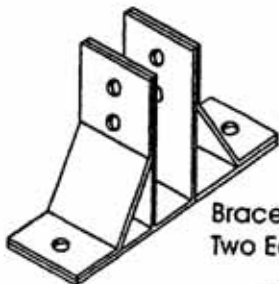

Braced  
Two Ear

#9SS4439

Braced Angle

#9SS4519



Inside Bracket

#9SS1209

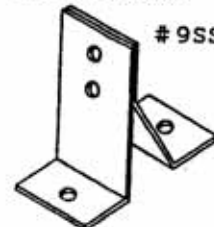



# Common Toilet Partition Hardware

## ADA\* LATCHES FOR USE WITH LIFT TYPE KEEPERS

### Fasteners Included, Chrome Plated Zamac Unless Indicated

NEXT DAY DELIVERY AVAILABLE



**SLIDE BOLT ASSEMBLY**  
2-3/4" Bet. Screws  
9/16" Bar to Door Clearance  
Part No. 9F0302 - Chrome  
Part No. 9F0302SS - Cast  
Stainless Steel



**SLIDE BOLT LATCH**  
2-3/4" Between Screws  
3/8" Bar to Door Clearance  
Part No. 90T160 - Chrome  
Part No. 9A5033 - Cast  
Stainless Steel



**SLIDE BOLT LATCH**  
3-1/2" Between Screws  
5/8" Bar to Door Clearance  
Part No. 9G0136 - Chrome  
Part No. 9A5053 - Cast  
Stainless Steel



**SLIDE BOLT LATCH**  
3-1/2" Between Screws  
3/8" Door to offset bar  
clearance  
Part No. 9G0137 - Chrome  
Part No. 9A5063 - Cast  
Stainless Steel



**SLIDE BOLT LATCH**  
2-5/8" Bet. Screws  
Part No. 9S7431



**STAINLESS STEEL**  
1-7/8" Between Screws  
1/8" Bar to Door Clearance  
Part No. 9A7055  
\* See Stainless Steel  
section for Keeper/stop



**SLIDE BOLT LATCH**  
Aluminum 3-1/2"  
Between Screws  
Part No. 9HLSLA



**SLIDE BOLT LATCH**  
Aluminum 3-1/2"  
Between Screws  
Part No. 9A0102



**SLIDE BOLT LATCH**  
with Indicator for  
1" doors  
2-3/4" bet. Screws  
Part No.  
9G2000 Cast SS



**THROW LATCH**  
Chrome Plated Brass  
3-1/2" Bet. Screws  
Part No. 9S7531



**INSWING LATCH & STRIKE**  
Stamped Stainless Steel  
Can be used for outswing  
if door and post are equal.  
Part No. 9A0104



**HEAVY DUTY THROW  
LATCH WITH KEEPER**  
Chrome Plated Brass  
Part No. 9S5701



**INSWING LATCH & KEEPER**  
Stamped Stainless Steel  
Part No. 9A0106



**LATCH WITH KEEPER**  
Indicator an Door Pull  
Part No. 9A6069

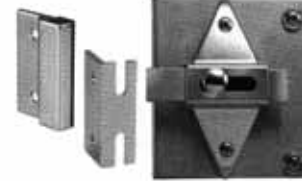

**CONCEALED LATCH FIX IT KITS**  
To cover up Concealed Latch Holes

- For Powder Coated Steel & Plastic Laminate Doors
- For 1" Thick Doors - Round Edge for Powder Coated
- Steel and for 1" Square edge for Plastic Laminate
- For 1-1/4" Pilasters
- All Hardware Included
- Slide Bolt Latch
- Inswing or Outswing Hardware (Keeper Bumper)
- Stainless Steel "U" Shape cover for both sides of door
- All Screws Included

### Chrome Plated Zamac

PART NO.	EDGE TYPE & DOOR SWING
9A1116	Round Edge Inswing
9A1117	Round Edge Outswing
9A1118	Square Edge Inswing
9A1119	Square Edge Outswing

### Stainless Steel

PART NO.	EDGE TYPE & DOOR SWING
9A1122	Round Edge Inswing
9A1123	Round Edge Outswing
9A1120	Square Edge Inswing
9A1121	Square Edge Outswing

\* PLEASE CHECK WITH YOUR LOCAL CODE TO VERIFY ADA REQUIREMENTS.

TOILET PARTITION HARDWARE

### Door Handles (Chrome Plated)



**DOOR PULL**  
3-1/2" Bet.  
Screws  
Part No. 9A0540



**DOOR PULL**  
4" Bet. Centers  
Part No. 9A0171



**DOOR PULL**  
2-3/4" Bet.  
Centers  
Part No. 9A0620



**DOOR PULL**  
3-1/2" Bet.  
Centers  
Part No. 9HH000



**DOOR PULL**  
2-5/8" Bet.  
Centers  
Part No. 9A7401

### ADA\* Door Pull



**ADA DOOR PULL**  
3" High x 5-1/8" Long

PART NO.	MATERIAL
9A6251	CHROME PLATED BRASS
9A0625	CAST STAINLESS STEEL

### Coat Hooks and Door Stops



**DOOR STOP**  
2" High  
Part No. 9A0412



**COAT HOOK DOUBLE PRONG**  
3" Projection,  
1-3/4" High  
Part No. 9G0161



**COAT HOOK & BUMPER**  
2-3/4" Projection,  
2-1/4" High  
Part No. 9HH900  
Part No. 9HH900SS - Cast SS



**COAT HOOK & BUMPER**  
3" Projection,  
2" High  
Part No. 9S7810



**COAT HOOK & BUMPER**  
3-1/2" Projection  
2-3/4" High  
Part No. 9G0160



**COAT HOOK & BUMPER**  
3-1/8" Projection,  
2-1/8" High  
Part No. 9G2008



**DOOR STOP - PILASTER MOUNTED**  
2-1/2" High x 4-1/4" Long

PART NO.	MATERIAL
9A4151	CHROME PLATED BRASS

**Coat Hook**  
Zinc or Chrome  
part no. 209

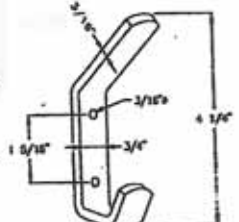

# Common Toilet Partition Hardware

## SQUARE EDGED WRAP AROUND HINGE SETS

• FASTENERS INCLUDED • CHROME PLATED ZAMAC UNLESS INDICATED

7/8" Thick Doors 1-1/4" Thick Pilasters

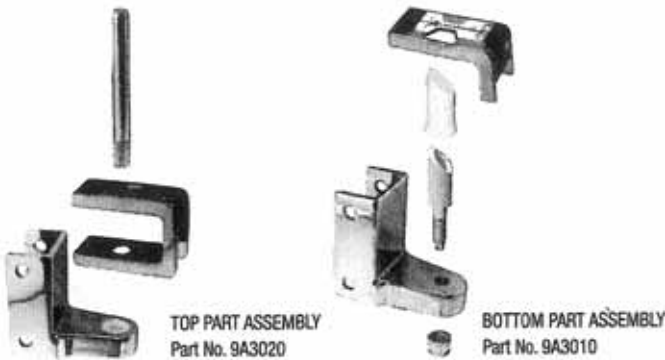

1" Thick Doors 1-1/4" Thick Pilasters



## FULL LENGTH SURFACE MOUNTED HINGES

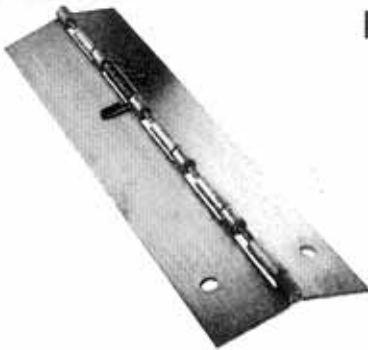

- STRENGTHEN YOUR DOOR
- PROVIDE MORE PRIVACY
- CAN BE RAISED 3/8" FOR EMERGENCY ENTRY
- STAMPED STAINLESS STEEL

### WITH SPRING TO SELF CLOSE

PART NO.	DOOR SWING	LENGTH
9A70C1	RH-OUT, LH-IN	57-1/2"
9A70C2	LH-OUT, RH-IN	57-1/2"
9A70C4	RH-OUT, LH-IN	54"
9A70C5	LH-OUT, RH-IN	54"

### WITHOUT SPRING

PART NO.	DOOR SWING	LENGTH
9A70C3	ALL	57-1/2"

## SURFACE MOUNTED HINGE SETS (UPPER AND LOWER)

### Medium Duty

	ROUND BARREL		
	MATERIAL	DOOR SWING	PART NO.
 1-1/2"	CHROME PLATED BRASS	FOR RIGHT HAND OUTSWING OR LEFT HAND INSWING	9A7021
		FOR LEFT HAND OUTSWING OR RIGHT HAND INSWING	9A7011
 1-1/2"	SATIN STAINLESS STEEL	FOR RIGHT HAND OUTSWING OR LEFT HAND INSWING	9A7043
		FOR LEFT HAND OUTSWING OR RIGHT HAND INSWING	9A7033
 1-1/2"	SATIN STAINLESS STEEL	FOR RIGHT HAND OUTSWING OR LEFT HAND INSWING	9A7103
		FOR LEFT HAND OUTSWING OR RIGHT HAND INSWING	9A7093

### Heavy Duty

	SQUARE BARREL		
	MATERIAL	DOOR SWING	PART NO.
 1-1/2"	SATIN STAINLESS STEEL	FOR RIGHT HAND OUTSWING OR LEFT HAND INSWING	9A7423
		FOR LEFT HAND OUTSWING OR RIGHT HAND INSWING	9A7413
 1-1/2"	POLISHED STAINLESS STEEL	FOR RIGHT HAND OUTSWING OR LEFT HAND INSWING	9A7083
		FOR LEFT HAND OUTSWING OR RIGHT HAND INSWING	9A7073

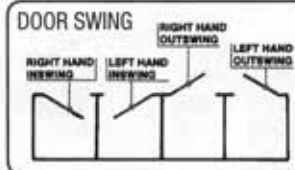

SUPPLIED WITH FASTENERS FOR 1" DOORS & 1-1/4" POST. OTHERS SCREWS AVAILABLE.

# Common Toilet Partition Hardware

## STRIKE AND KEEPERS FOR SQUARE EDGE POSTS

Fasteners Included, Chrome Plated Zamac Unless Indicated

NEXT DAY DELIVERY AVAILABLE



**KEEPER BUMPER**  
For Inswing  
1-1/2" bet.screws



**KEEPER BUMPER**  
For Outswing  
1-1/2" bet.screws



 **KEEPER BUMPER**  
For Inswing  
1-1/2" bet.screws



**KEEPER BUMPER**  
For Inswing and Outswing  
for Concealed Latch

PART NO.	POST SIZE
CHROME PLATED	
9A5620	1"
9F0304	1-1/4"
CAST STAINLESS STEEL	
9A5623	1"
9A5113	1.25"

PART NO.	POST SIZE
CHROME PLATED	
9A5720	1"
9F0303	1-1/4"
CAST STAINLESS STEEL	
9A5723	1"
9A5213	1.25"

PART NO.	POST SIZE
CHROME PLATED	
9A5820	1"
9S410T	1-1/4"
CAST STAINLESS STEEL	
9A4903	3/4"
9A5823	1"
9A5343	1.25"

PART NO.	POST SIZE
CHROME PLATED	
9A5730	1"
92560E	1-1/4"
CAST STAINLESS STEEL	
9A5733	1"
9A5233	1.25"



**KEEPER BUMPER**  
For Inswing  
1-9/16" bet. screws  
Flat surface type  
Part No. 90T116 Chrome  
Part No. 9A5143 Cast SS



**KEEPER BUMPER**  
For Outswing  
1-1/2" bet. screws  
Flat surface type  
Part No. 9A5240 Chrome  
Part No. 9A5243 Cast SS



**KEEPER BUMPER**  
For Outswing  
1-1/2" bet. screws  
Flat surface type  
Part No. 9A5260 Chrome  
Part No. 9A5263 Cast SS



 **KEEPER BUMPER**  
For Inswing  
1-1/2" bet. screws  
Flat surface type  
Part No. 9A5985 Chrome  
Part No. 9A5283 Cast SS



**KEEPER STOP**  
ANY THICKNESS POST  
1-7/8" Bet. Screws  
Inswing use:  
Keeper - Part No. 9A7056  
and  
Stop - Part No. 9A7057  
Outswing ONLY use:  
Part No. 9A7057



**KEEPER**

**STOP**

ANY THICKNESS POST  
1-1/2" Bet. Screws  
Inswing use:  
Keeper -  
Part No. 9S2401J Chrome  
and  
Stop:  
Part No. 9S2704 Chrome  
Part No. 9A5173 Cast SS  
Outswing ONLY use:  
Part No. 9S2704 Chrome



**KEEPER**

**STOP**

ANY THICKNESS POST  
1-1/2" Bet. Screws  
Inswing use:  
Keeper -  
Part No. 9S2701 Chrome  
Part No. 9A5183 Cast SS  
and  
Stop:  
Part No. 9S2704 Chrome  
Part No. 9A5173 Cast SS  
Outswing ONLY use:  
Part No. 9S2704 Chrome



**KEEPER BUMPER**  
For Outswing  
1-1/4" Post  
Part No. 9A5970 Chrome  
Part No. 9A5973 Cast SS



**KEEPER BUMPER**  
For Inswing  
1-1/4" Post  
Part No. 9A5980 Chrome  
Part No. 9A5983 Cast SS



**KEEPER BUMPER**  
Inswing or Outswing  
for Concealed Latch  
1-1/4" Post  
Part No. 9F0227 Chrome



**KEEPER BUMPER**  
For Outswing  
Flat Surface  
Part No. 9A5640 Chrome  
Part No. 9A5643 Cast SS



**KEEPER BUMPER**  
For Inswing  
Flat Surface  
Part No. 9A5990 Chrome  
Part No. 9A5653 Cast SS



**KEEPER BUMPER**  
Inswing or Outswing  
for Concealed Latch  
1-1/4" Post  
Part No. 9K1152 Chrome

## STRIKE AND KEEPERS FOR ROUND EDGE POSTS

Fasteners Included, Chrome Plated Zamac Unless Indicated



**KEEPER BUMPER**  
For Inswing 1-1/4" Post  
Part No. 9G0151 - Chrome



**KEEPER BUMPER**  
For Inswing 1-1/4" Post  
Part No. 9A5330 - Chrome



**KEEPER BUMPER**  
For Outswing 1-1/4" Post  
Part No. 9G015E - Chrome



**KEEPER BUMPER**  
For Outswing 1-1/4" Post  
Part No. 9A5570 - Chrome  
Part No. 9A5573 - Cast SS



**KEEPER BUMPER**  
For Inswing 1-1/4" Post  
Part No. 9A5580 - Chrome  
Part No. 9A5583 - Cast SS



**KEEPER BUMPER**  
For Inswing or Outswing 1-1/4" Post  
7/16" w x 3/4" h slot.  
Part No. 92060B - Chrome  
Part No. 9A5513 - Cast SS



**KEEPER BUMPER**  
For Inswing or Outswing 1-1/4" Post  
1/4" w x 3/4" h slot.  
Part No. 90C410 - Chrome

TOILET PARTITION HARDWARE

# Toilet Partition Hardware

## AMPCO

### For use on Metal



### For use on Plastic Laminate



### For use on Metal and Plastic Laminate



## HADRIAN - Chrome Plated Hardware



TOILET PARTITION HARDWARE

# Toilet Partition Hardware

## COMTEC / CAPITAL / HINY HIDERS



STRIKE/KEEPER  
INSWING ALUMINUM  
6" High  
Part No. 9HSISA



STRIKE/KEEPER  
OUTSWING ALUMINUM  
8" High  
Part No. 9HSOSA



SLIDE LATCH  
ALUMINUM  
3 1/2" between screws  
Part No. 9HLSLA

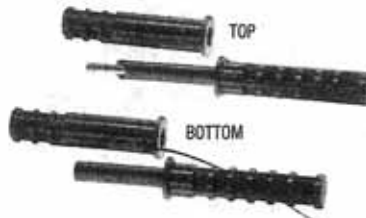

REPLACEMENT HINGE INSERTS  
Part No. 9HHGB-TOP  
Part No. 9HHGB-BOTTOM



HINGE SET  
SET OF 2 HINGES  
8" High. Instructions Included  
Part No. 9HHGB



ADA HINGE SET  
SET OF 3 HINGES  
8" High. Instructions Included  
Part No. 9HHGBADA

## FIAT - Chrome Plated Hardware



TOP HINGE  
1-1/2" Bet. Screws  
Part No. 9F0211N



BOTTOM HINGE  
1-1/2" Bet. Screws  
Part No. 9F0301  
A = 1-11/16"



TOP HINGE  
1-1/2" Bet. Screws  
Part No. 9F0300  
A = 1-11/16"



BOTTOM HINGE  
Part No. 9F0214N  
A = 1-11/16"



TOP HINGE  
DOOR ESCUTCHEON  
For 1" Thick Doors  
Part No. 9F0316



BOTTOM HINGE  
DOOR INSERT  
For 1" Thick Doors  
Part No. 9F0317



SLIDE BOLT ASSEMBLY  
2-3/4" Bet. Screws  
9/16" Bar to Door Clearance  
Part No. 9F0302



KEEPER BUMPER  
Part No. 9F0227

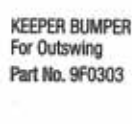

KEEPER BUMPER  
For Outswing  
Part No. 9F0303



RUBBER ONLY  
Part No. 9F0380

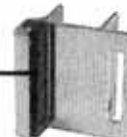

KEEPER BUMPER  
For Inswing  
Part No. 9F0304



TOP PIN (Metal)  
3/8" Dia.  
3-7/16" Long  
Part No. 9F0310



TOP PIN (Metal)  
7/16" Dia.  
3-3/16" Long  
Part No. 9F0207N



NYLON CAM  
Part No. 9F0312



PINTLE  
11/16" Dia.  
Part No. 9F0311

(New) Part No. 925008



INCLUDES PIN  
When Ordering  
Specify Pin Type



Straight or Offset

## FLUSH METAL

For use on Metal



TOP HINGE  
1-1/2" Bet. Screws  
Part No. 9FL100  
A = 1-7/16"



BOTTOM HINGE  
1-1/2" Bet. Screws  
Part No. 9FL200  
A = 1-7/16"



BOTTOM CAM HOUSING  
FRONT (Unplated)  
Part No. 9FL275



TOP HINGE CASTING  
For use on metal.  
Part No. 9FL265



KEEPER BUMPER  
Part No. 9FL400



COAT HOOK & BUMPER  
Part No. 9FL450



NYLON CAM  
Part No. 9FL225



PINTLE  
5/8" Dia.  
Part No. 9FL250



TOP PIN  
3/8" Dia., 3" Long  
Part No. 9FL125



LATCH KNOB & COVER  
(Concealed)  
Part No. 9FL325



KNOB & COVER  
Part No. 9FL325A

TOILET PARTITION HARDWARE

# Toilet Partition Hardware

## FLUSH METAL *continued*

### For use on Plastic Laminate



**TOP HINGE**  
1-1/2" Bet. Screws  
For 1-1/4" Sq. Post  
Part No. 9FL600  
A = 1-5/8"



**BOTTOM HINGE**  
1-1/2" Bet. Screws  
For 1-1/4" Sq. Post  
Part No. 9FL700  
A = 1-5/8"

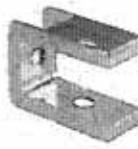

**TOP HINGE DOOR ESCUTCHEON**  
For 7/8" Thick Doors  
Part No. 9FL650



**BOTTOM HINGE DOOR INSERT**  
Part No. 9FL775



**TOP PIN (Metal)**  
3/8" Dia.  
3-1/2" Long  
Part No. 9FL625



**KEEPER BUMPER**  
For Outswing  
For 1-1/4" Sq. Post  
Part No. 9FL900



**KEEPER BUMPER**  
For Inswing  
For 1-1/4" Sq. Post  
Part No. 9FL925



**SLIDE BOLT ASSEMBLY**  
2-3/4" Bet. Screws  
Part No. 9FL800



**NYLON CAM**  
Part No. 9FL725



**PINTLE**  
15/32" Dia.  
Part No. 9FL750

## GENERAL

### For use on Plastic Laminate



**TOP HINGE**  
1-1/2" Bet. Screws  
For 1-1/4" Sq. Post  
Part No. 91500P  
A = 1-11/16"



**BOTTOM HINGE**  
1-1/2" Bet. Screws  
For 1-1/4" Sq. Post  
Part No. 91000P  
A = 1-11/16"



**SLIDE BOLT LATCH**  
2-3/4" Bet. Screws  
9/16" Bar to Door Clearance  
Part No. 92000P



**KEEPER BUMPER**  
For Inswing  
For 1-1/4" Sq. Post  
Part No. 920601



**KEEPER BUMPER**  
For Outswing  
For 1-1/4" Sq. Post  
Part No. 92060E

### For Use on Metal

#### Older Style



**TOP HINGE**  
1-1/2" Bet. Screws  
For 1-1/4" Rnd. Post  
Part No. 91500B



**BOTTOM HINGE**  
1-1/2" Bet. Screws  
For 1-1/4" Rnd. Post  
Part No. 91000B  
A = 1-5/8"



**KEEPER BUMPER**  
For Inswing and Outswing  
For 1-1/4" Rnd. Post  
Part No. 92560E



**KEEPER BUMPER**  
For 1-1/4" Rnd. Post  
Part No. 92060B



**BOTTOM CAM HOUSING (Unplated)**  
Part No. 91005B



**TOP PIN (Metal)**  
3/8" Dia.  
3-3/4" Long  
Part No. 91504B



**PINTLE**  
11/16" Dia.  
Part No. 91006B



**LATCH KNOB (Obsolete)**  
Use Part No. 92500B or 92500C



**NYLON CAM**  
Part No. 91002B

(New) Part No. 92500B INCLUDES PIN When Ordering Specify Pin Type

Straight or Offset



**TOP PIN**  
3/8" Dia.  
3" Long  
For 91500B & 91500P  
Part No. 91503B



**LATCH KNOB & COVER (Concealed)**  
Part No. 92000C



**LATCH KNOB**  
Part No. 92500C

#### Newer Style



**TOP HINGE**  
1-1/8" Bet. Screws  
For 1-1/4" Rnd. Post  
Part No. 96320A  
A = 1-11/16"



**BOTTOM HINGE**  
1-1/8" Bet. Screws  
For 1-1/4" Rnd. Post  
Part No. 96319A  
A = 1-11/16"



**BUMPER KEEPER**  
For 1-1/4" Rnd. Post  
Part No. 96317A



**LATCH KNOB (Concealed)**  
Part No. 96318A



**LATCH COVER (Concealed)**  
Part No. 96318B



**LATCH KNOB (Concealed)**  
Part No. 96318AA



**BOTTOM CAM & PINTLE**  
Part No. 96319E



**TOP PIN**  
1/4" Dia.  
2-7/8" Long  
Part No. 96320B

TOILET PARTITION HARDWARE

# Toilet Partition Hardware

## ACCURATE – Chrome Plated Hardware

### For use on Metal

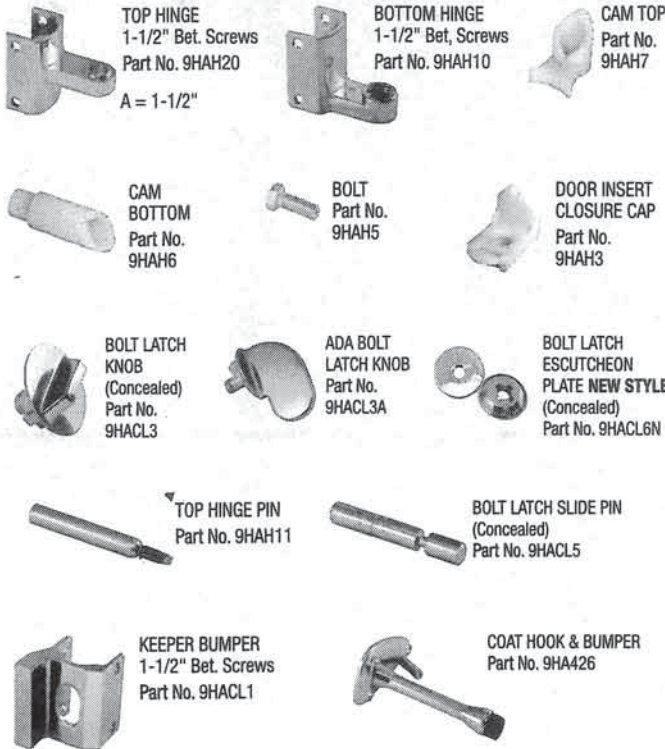

TOP HINGE  
1-1/2" Bet. Screws  
Part No. 9HAH20  
A = 1-1/2"

BOTTOM HINGE  
1-1/2" Bet. Screws  
Part No. 9HAH10

CAM TOP  
Part No. 9AH47

CAM BOTTOM  
Part No. 9AH46

BOLT  
Part No. 9AH45

DOOR INSERT  
CLOSURE CAP  
Part No. 9AH43

BOLT LATCH  
KNOB  
(Concealed)  
Part No. 9HACL3

ADA BOLT  
LATCH KNOB  
Part No. 9HACL3A

BOLT LATCH  
ESCUTCHEON  
PLATE NEW STYLE  
(Concealed)  
Part No. 9HACL6N

TOP HINGE PIN  
Part No. 9AH411

BOLT LATCH SLIDE PIN  
(Concealed)  
Part No. 9HACL5

KEEPER BUMPER  
1-1/2" Bet. Screws  
Part No. 9HACL1

COAT HOOK & BUMPER  
Part No. 9HA426

### How to Identify Hardware

Top and Bottom hinges are more easily identified by measuring the distance "A" on your hinge and comparing it to "A" next to the part.

Side view of Hinge

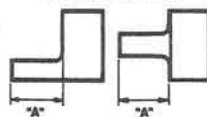

Screws Are Supplied with All Hardware

### For use on Plastic Laminate

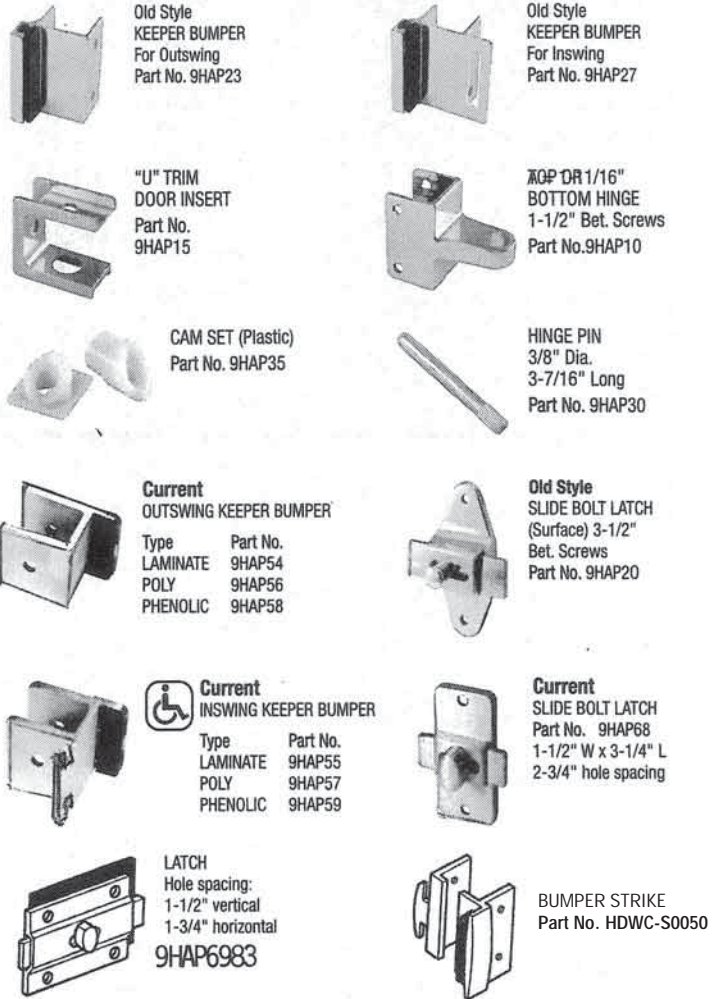

Old Style  
KEEPER BUMPER  
For Outswing  
Part No. 9HAP23

Old Style  
KEEPER BUMPER  
For Inswing  
Part No. 9HAP27

"U" TRIM  
DOOR INSERT  
Part No. 9HAP15

TOP DR 1/16"  
BOTTOM HINGE  
1-1/2" Bet. Screws  
Part No. 9HAP10

CAM SET (Plastic)  
Part No. 9HAP35

HINGE PIN  
3/8" Dia.  
3-7/16" Long  
Part No. 9HAP30

Current  
OUTSWING KEEPER BUMPER  
Type Part No.  
LAMINATE 9HAP54  
POLY 9HAP56  
PHENOLIC 9HAP58

Old Style  
SLIDE BOLT LATCH  
(Surface) 3-1/2"  
Bet. Screws  
Part No. 9HAP20

Current  
INSWING KEEPER BUMPER  
Type Part No.  
LAMINATE 9HAP55  
POLY 9HAP57  
PHENOLIC 9HAP59

Current  
SLIDE BOLT LATCH  
Part No. 9HAP68  
1-1/2" W x 3-1/4" L  
2-3/4" hole spacing

LATCH  
Hole spacing:  
1-1/2" vertical  
1-3/4" horizontal  
9HAP6983

BUMPER STRIKE  
Part No. HDWC-S0050

## Toilet Partition Hardware Fasteners

### UN-DO-IT

For Removing One-Way Screws



For #12 & #14 Screws	9A0810
For #8 & #10 Screws	9A0807
For #6 & #8 Screws	9A0804
Three-Pack	9A0801
One of each	

### ONE-WAY SHEET METAL SCREWS

Chrome Plated Steel Available 100/Box

PART NO.	DESCRIPTION	USE
9A7022	#10 x 5/8 long - 11/32 dia. head, 3/16 dia. thread	Coat Hooks #9F0217 Slide Bolt Latch, #9F0211N & #9F0214N Hinges
9A7087	#10 x 1" long - 3/16" dia., Phillips Tapered head	Door Inserts, Cam Housings, Flat Keeper Bumpers
9A7073	#12 x 1-1/2" long - 13/32 dia. head 7/32 dia., thread	Bracket to wall
9A0121	#12 x 1" Plastic Plug Anchor	#9A7073 Screws
9A7040	#14 x 5/8" long - 15/32 dia., head, 1/4 dia. thread	Bracket to Panel & Bracket to Pilaster #9S7531 Throw Latch
9A7010	#10 x 3" Long - 7/16 dia.	Attaches brackets to drywall/head toggle

### ONE-WAY SHOULDER SCREW & BARREL NUT

10-24 Thread



PART NO.	GRIP RANGE
9SS075	3/4" - 7/8"
9SS087	7/8" - 1-1/16"
9SS106	1-1/16" - 1-5/16" 1" door slide bolt latches 1" panel brackets
9SS131	1-5/16" - 1-5/8" 1-1/4" Pilaster brackets, keeper bumpers & hinges

TOILET PARTITION HARDWARE

# Toilet Partition Hardware

## SANYMETAL -Chrome Plated Hardware

### For use on Metal



**TOP HINGE**  
1-1/4" Bet. Screws  
For 1-1/4" Rnd. Post  
Part No. 9S7780  
(SET)  
A = 1-9/16"



**TOP HINGE CASTING**  
For Metal Doors



**PLASTIC PIN**  
For 7361, 5861 & 7780  
3/8" Dia.  
2-1/2" Long



**BOTTOM HINGE**  
1-1/4" Bet. Screws  
For 1-1/4" Rnd. Post  
Part No. 9S7770  
(SET)  
A = 1-9/16"



**BOTTOM POWER BEARING**  
(Concealed)



**OBSOLETE TOP HINGE**  
Replaced with  
Part No. 9S7780



**OBSOLETE BOTTOM HINGE**  
Replaced with  
Part No. 9S7770



**OBSOLETE TOP HINGE**  
Replace with  
Part No. 9S7361

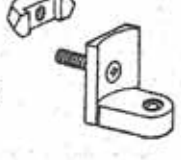

**OBSOLETE BOTTOM HINGE**  
Replace with  
Part No. 9S7360

**LATCH KNOB, COVER & PIN KIT PART NO. 9S8819**



Latch Knob



Latch Cover



Latch Pin



**STOP**  
1-1/2" Bet. Screws  
Part No. 9S2704



**SLIDE BOLT/LATCH**  
2-5/8" Bet. Screws  
Part No. 9S7431

**POST TOGGLE & SCREW**  
For 9S6403 and 9S6402 Hinges  
Part No. 9S5863

**LATCH KNOB & COVER PART NO. 9S8820**



Notched



 **KEEPER BUMPER**  
For Inswing  
For 1-1/4" Sq. Post  
Part No. 9S410T



 **KEEPER**  
1-1/2" Bet. Screws  
Part No. 9S2701



 **THROW LATCH**  
3-1/2" Bet. Screws  
Part No. 9S7531



**KEEPER**  
For Latch  
2" Bet. Screws  
Part No. 9S2401



**BUMPER**  
For Latch  
2" Bet. Screws  
Part No. 9S2400



**Keeper Bumper**  
For 1-1/4" Rnd. Post  
Part No. 9S8801

### For use on Plastic Laminate and Metal



**TOP HINGE**  
1-1/4" Bet. Screws  
For 1-1/4" Sq. Post  
Part No. 9S7361  
A = 1-1/2"



**BOTTOM HINGE**  
1-1/4" Bet. Screws  
For 1-1/4" Sq. Post  
Part No. 9S7360  
A = 1-1/2"



**KEEPER BUMPER**  
For 1-1/4" Sq. Post  
Part No. 9S8861



**COAT HOOK & BUMPER**  
Part No. 9S7810



**TOP DOOR HINGE**  
ESCTCHEON  
Part No. 9S6101



**COAT HOOK & BUMPER**  
Part No. 9S6810B

TOILET PARTITION HARDWARE



# Toilet Partition Hardware

## GLOBAL - Chrome Plated Hardware

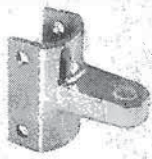

**TOP HINGE**  
1-1/2" Bet. Screws  
Part No. 9G0225  
A = 1-7/16"



**BOTTOM HINGE**  
1-1/2" Bet. Screws  
Part No. 9G0230  
A = 1-7/16"

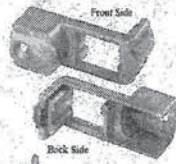

**BOTTOM CAM HOUSING (Unplated)**  
Part No. 9G0240



**PINTLE**  
5/8"  
Part No. 9G0237



**NYLON CAM**  
Part No. 9G0232

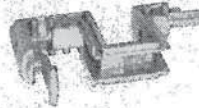

**TOP HINGE CASTING**  
Part No. 9G0220



**PIN**  
3/8" Dia. x 3" Long  
Part No. 9G2252

## For use on Metal



**KEEPER BUMPER**  
For Outswing  
Part No. 9G015E

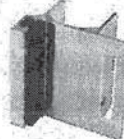

**KEEPER BUMPER**  
For Inswing  
Part No. 9G015I



**KEEPER BUMPER**  
Part No. 9G150C



**SLIDE BOLT LATCH (Surface)**  
3-1/2" Bet. Screws  
5/8" Bar to Door Clearance  
Part No. 9G0136

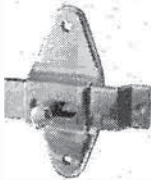

**SLIDE BOLT LATCH**  
With 3/8" Door to  
Offset Bar Clearance  
Part No. 9G0137

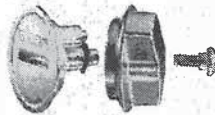

**LATCH KNOB & COVER (Screw Fastened/Concealed)**  
Part No. 9G0139S

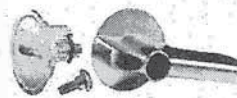

**KNOB & COVER (Screw fastened)**  
Part No. 9G0139AS



**LATCH KNOB & COVER (Concealed)**  
Part No. 9G0139



**KNOB & COVER**  
Part No. 9G0139A

## For use on Plastic Laminate

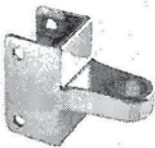

**TOP OR BOTTOM HINGE**  
1-1/2" Bet. Screws  
Part No. 9G631A



**"U" TRIM DOOR INSERT**  
Part No. 9G631B

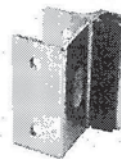

**KEEPER BUMPER**  
For Inswing and Outswing  
Part No. 9G631H



**CAM SET (Plastic)**  
Part No. 9G631E



**HINGE PIN (Metal)**  
3/8" Dia. x 3-7/16" Long  
Part No. 9G631C



**(New) LATCH COVER & KNOB**  
Part No. 9G631F

### See Accurate for replacement

Latch



Keeper

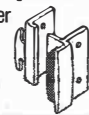

Bumper

## BOBRICK

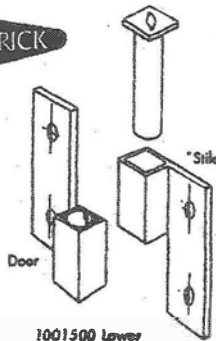

1001500 Lower

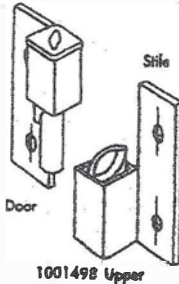

1001498 Upper

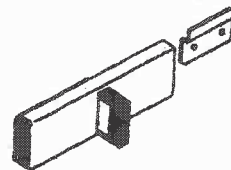

**BOBRICK SLIDE LATCH (Substitute)**  
Part #9A9099

**INSWING KEEPER #1000180**

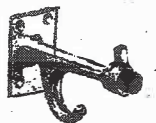

**#B-212 CLOTHES HOOK AND BUMPER**

**#B-233 CLOTHES HOOK**



TOILET PARTITION HARDWARE

MANY MORE PARTS AVAILABLE  
COMPLETE BOBRICK HARDWARE KITS AVAILABLE

# Toilet Partition Hardware

## KNICKERBOCKER - Chrome Plated Hardware

### For use on Metal



TOP HINGE  
1-1/8" Bet. Screws  
Part No. 9K0240  
A = 1-11/16"



BOTTOM HINGE  
1-1/8" Bet. Screws  
For 9KCAMM & 9K0231  
Part No. 9K0230  
A = 1-11/16"



DOOR STRIKE & KEEPER  
Part No. 9K0152



BOTTOM CAM  
Part No. 9KCAMM



BOTTOM CAM HOUSING  
Part No. 9K0340  
Not Plated



TOP PIN (PLASTIC)  
1/4" Dia. x 2-3/4" Long  
Part No. 9K0241M

### For use on Plastic Laminate



TOP HINGE  
1-1/8" Bet. Screws  
Part No. 9K1240  
A = 1-11/16"



BOTTOM HINGE  
1-1/8" Bet. Screws  
Part No. 9K1230  
A = 1-11/16"



BUMPER KEEPER  
Part No. 9K1152



BOTTOM HOUSING  
Part No. 9K1340



TOP PIN  
1/4" Dia. X 2-7/8" Long  
Part No. 9K241P



BOTTOM CAM  
Part No. 9KCAMP



DOOR LATCH INSIDE  
MECHANISM-KIT  
Part No. 9K0253

### For use on Plastic Laminate and Metal

LATCH KNOB  
(Concealed)  
Part No. 9K0250



LATCH COVER  
(Concealed)  
Part No. 9K0255



LATCH KNOB  
(Concealed)  
Part No. 9K0250A



PINTLE  
9/16" Dia.  
Part No. 9K0231

## METPAR

### For use on Plastic Laminate and Metal



TOP HINGE  
1-1/2" Bet. Screws  
Part No. 9CP400  
A = 1-13/16"



BOTTOM HINGE  
1-1/2" Bet. Screws  
Part No. 9CP300  
A = 1-13/16"



TOP HINGE  
DOOR ESCUTCHEON  
For 7/8" Thick Doors  
Part No. 9CP425



BOTTOM HINGE  
DOOR INSERT  
Part No. 9CP325

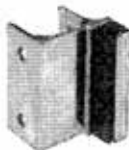

KEEPER BUMPER  
For Outswing  
Part No. 9CP200

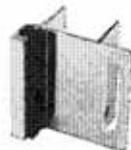

KEEPER BUMPER  
For Inswing  
Part No. 9CP250



SLIDE BOLT LATCH  
2-3/4" Bet. Screws  
Part No. 9CP100



TOP PIN (Metal)  
3/8" Dia.  
3-1/2" Long  
Part No. 9CP450



NYLON CAM  
Part No. 9CP375



PINTLE  
1/2" Dia.  
Part No. 9CP350

# Toilet Partition Hardware

## METPAR *continued*

### For use on Metal



**TOP HINGE**  
1-1/2" Bet. Screws  
Part No. 9C3503  
A = 1-7/16"



**BOTTOM HINGE**  
1-1/2" Bet. Screws  
Part No. 9C3004  
A = 1-7/16"

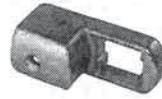

**BOTTOM CAM HOUSING**  
Part No. 9C0140



**TOP HINGE CASTING**  
Part No. 9C3513



**KEEPER BUMPER**  
Part No. 90C410



**LATCH COVER & KNOB (Concealed)**  
Part No. 90C300



**LATCH COVER & KNOB**  
Part No. 90C300A

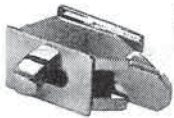

**SLIDE BOLT LATCH**  
Part No. 90C400



**NYLON CAM**  
Part No. 9C3002



**PINTLE**  
5/8" Dia.  
Part No. 9C3006



**NYLON CAM Pintle Combination**  
Part No. 9C0235



**TOP PIN (Metal)**  
3/8" Dia.  
3-3/4" Long  
Part No. 9C3505



**TOP PIN (Metal)**  
3/8" Dia.  
3" Long  
Part No. 9C3504



**If in Doubt Please Send a Sample**

## MILLS - Chrome Plated Hardware

### Obsolete! Ask for Replacement



**(Old Style) SLIDE BOLT/LATCH**  
1-7/8" Bet. Screws  
5/16" Bars to Door Clearance  
Part No. 90T160



**KEEPER BUMPER (Porc.)**  
Part No. 90T317

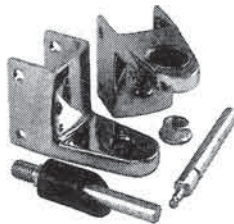

**TOP & BOTTOM HINGE**  
1-3/8" Bet. Screws  
Part No. 90T100-110

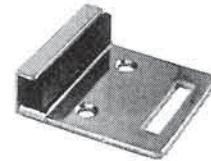

**KEEPER BUMPER**  
Part No. 90T116



**KEEPER BUMPER (Porc.)**  
Part No. 90T317



**LATCH**  
Hole spacing:  
1-1/2" vertical  
1-3/4" horizontal  
**9HAP6983**

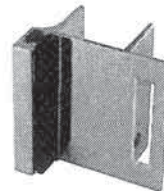

**BUMPER KEEPER**  
Part No. 90T120

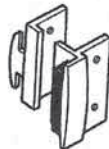

**BUMPER STRIKE**  
Part No. HDWC-S0050



**New Style SLIDE BOLT/LATCH (Concealed)**  
Part No. 90T290

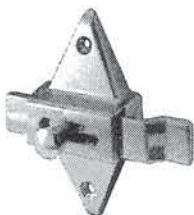

**SLIDE BOLT/LATCH**  
1-7/8" Bet. Screws  
5/16" Bars to Door Clearance  
Part No. 90T160

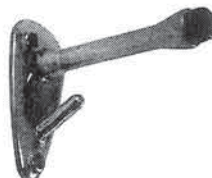

**COAT HOOK & BUMPER**  
3-3/8" Projection  
2-3/4" High  
Part No. 90T285

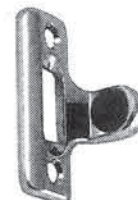

**KEEPER BUMPER (18 GA.)**  
1-5/8" Bet. Screws  
Part No. 90T316

# GSS TOILET PARTITION HARDWARE

DOOR HINGE 507-201

NYLON CAM 509-206

DOOR HINGE HOUSING 507-501

DOOR BUMPER 507-204

#10 x 1/2" TYPE A SHEET METAL SCREW 507-303

#14 x 1/2" SHEET METAL SCREW 507-302

IN SWING BUMPER (for slide latch) 507-225

5/16-20 x 3/4 MACH. SCREW 507-306

LATCH PIN ONLY P8309

Offset Bracket 507-212

Wall Bracket 507-213

Offset Bracket 507-214

Bumper/Coathook 507-205

CONCEALED LATCH 507-202

HARDWARE HINGE KIT FOR DOORS (INCLUDES SLIDE LATCH)

**Bottom Hinge assembly**

**Top Hinge assembly**

Upper or Lower Hinge 507-269

Cam Rivet

Top Nylon Cam

599-500

Upper Hinge

Cam Rivet

Top Nylon Cam

599-504

Nylon Housing Block

Bottom Nylon Cam

(High Point on cam faces out from hinge)

599-723 OUT SWING KIT

599-724 STANDARD KIT

Slide Bolt Assembly 507203

Cam Rivet

## Fleming

A = 1-5/8"

A = 1-5/8"

FL91500B Top Hinge

FL91000B Bottom Hinge

1-1/2" Bet. Screws

1-1/2" Bet. Screws

Latch Cover (Concealed) FL92001C

Latch Knob (Concealed) FL92000C

Coat Hook & Bumper FL9G0160

Pintle 11/16" Dia. FL91006B FOR FL91000

Keeper Bumper FL92060B

Bottom Cam Housing FL91005B

Nylon Cam FL91002B FOR FL91000B

Top Pin (Plastic) 3/8" Dia. 3-5/8" Long FL91503B FOR FL91500B

Offset Bracket FL508B

Panel Bracket FL509B

Panel Bracket FL5103

# Common Toilet Partition Hardware

## Urinal Screen Brackets



**Two Ear**  
FOR ANY THICKNESS SCREEN  
3-1/2" Long  
Part No. 9A1320

FOR 1-1/4" SCREEN  
6" Long  
Part No. 9AWB25  
FOR 1" SCREEN  
12" Long  
Part No. 9AWB27

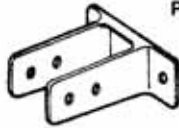

FOR 1-1/4" SCREEN  
Part No. 9A1330  
FOR 1" SCREEN  
Part No. 9A1280

## Partition Brace

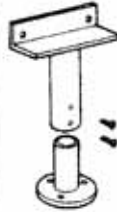

**PARTITION BRACE**  
Stainless Steel  
Floor Mounted Unit  
supports 1/2" to  
1-1/2" thick panels.  
Height is  
adjustable from  
11-1/4" to 18"  
Part No.  
9A6005

Call or Write  
for More Information

## Continuous Panel / Screen Brackets

**Aluminum**  
58" Long

"U" BRACKET  
1-3/8" high for  
1" Panel / Screen  
Part No. 9A0191C

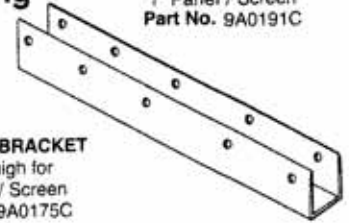

**TWO-EAR BRACKET**  
2-3/4" high for  
1" Panel / Screen  
Part No. 9A0175C

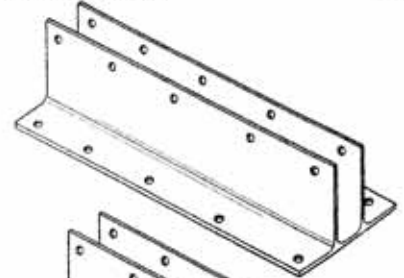

**ONE-EAR BRACKET**  
2-3/4" high for  
1" Panel / Screen  
Part No. 9A0176C  
For 1-1/4" Pilaster / Screen  
Part No. 9A0184C

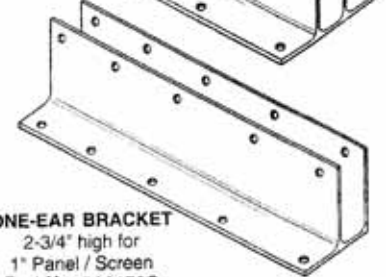

## Panel / Pilaster Brackets

Chrome Plated



**ALCOVE CLIP**  
1" Panel to  
1-1/4" Pilaster  
Part No. 9A0155

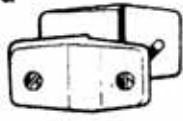

**ALCOVE CLIP SETS**  
(2 Per Set)  
Used to join Panel to  
Pilaster edge to edge.  
4 Sets of Two required  
per Panel.  
Part No. 9A8340

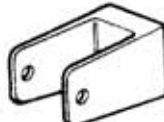

"U" BRACKET  
1-3/8" Long

Part No.	Panel/Pilaster Thickness
9A0189	.75
9A0190	.875
9A0191	1.0
9A0194	1.25

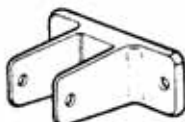

**TWO-EAR BRACKET**  
2-1/2" Long

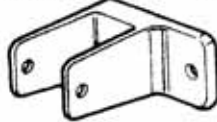

**ONE EAR BRACKET**  
2-1/2" Long

Part No.	Panel/Pilaster Thickness
9A0162	.75
9A0163	.875
9A0175	1.0
9A0183	1.25

Part No.	Panel/Pilaster Thickness
9A0164	.75
9A0165	.875
9A0176	1.0
9A0184	1.25

**ANGLE BRACKETS**  
1-3/4" x 1-3/4"  
Part No.  
9A0160



## Headrail Brackets



**END PLUG**  
For 1-1/2" x 1"  
Rectangular Tubing  
Part No.  
9A0666



**END PLUG**  
For 1-1/2" x 1"  
Anti-Grip Tubing  
Part No. 9A0667  
For 1" x 7/8"  
Anti-Grip Tubing  
Part No. 9A0665



**BRACKET**  
For 1-3/8" thick  
Headrail  
Part No.  
9A0213



**BRACKET**  
For 1" Thick  
Headrail  
Part No.  
9A0216

## Pilaster — Stainless Steel Shoes 3" High



**ROUND EDGE PILASTER SHOE**  
One End Split for Easy Installation.  
1-1/4" x 2", 3", 4", 5", 6",  
7", 8", 10", 12", 18" & 24"  
Part No. 9A0308



**SQUARE EDGE PILASTER SHOE**  
1-1/4" x 2", 3", 4", 5", 6",  
8", 10", 12" & 14"  
Part No. 9A0306



**FLOOR SHOE**  
For 1-3/4" x  
1-3/4" Post  
Part No. 9A0304



**FLOOR SHOE**  
For 1-1/4" x 1-1/4" Post  
Part No. 9A1763

## Pilaster Anchoring Devices

Very Popular

Number to Use	Pilaster Width	Part No.
1	2"	9A07192
1	3, 4, 5, 6"	9A07193
2	7+"	9A07194

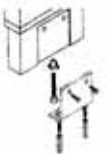

FOR 1-1/4" & 1-1/8"  
THICK AND UP TO  
6" WIDE PILASTERS  
Part No. 9A0309

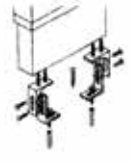

POPULAR FOR 3/4"  
AND THICKER AND UP  
TO 6" WIDE  
PILASTERS  
Part No. 9A1056

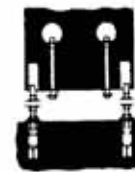

**PILASTER ANCHOR PACK**  
For Plastic Laminate  
All Necessary Screws,  
Nuts and Anchors  
Included  
Part No. 9A0310

# TOILET PARTITION HARDWARE

## SHANAHAN'S

### PANEL AND PILASTER BRACKETS

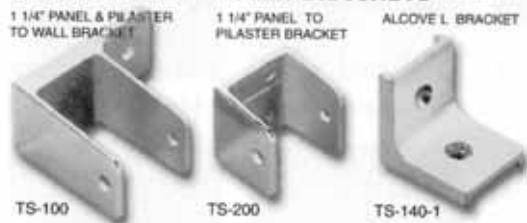

### PILASTER HARDWARE



### CONCEALED DOOR HARDWARE

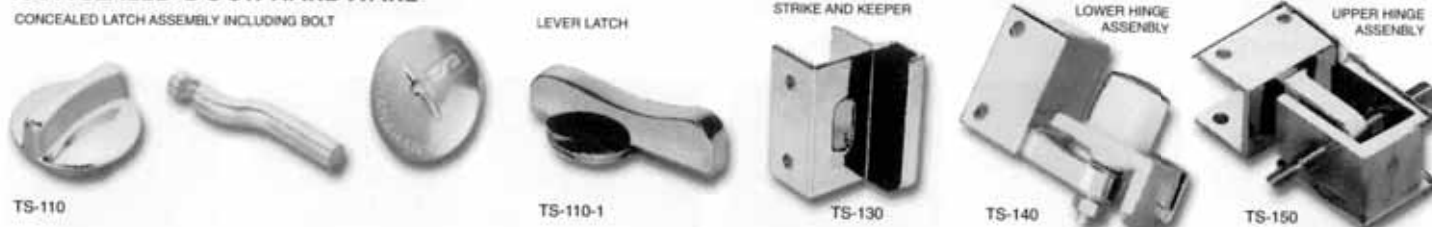

### SURFACE DOOR HARDWARE

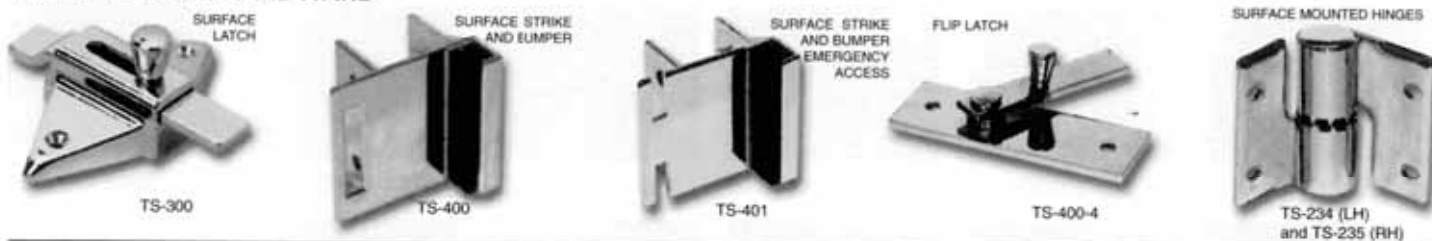

### DOOR HARDWARE ACCESSORIES



### HEADRAIL AND HEADRAIL BRACKETS



### SHOWER AND CHANGE STALL HARDWARE



### SCREEN HARDWARE



All standard door, panel and pilaster hardware are chrome-plated zinc die castings (Zamac).

Brackets, concealed door hardware, shoes and headrail are manufactured to fit Shanahan's 1 1/4" square edge.

Replacement and special parts are available upon request.

# FIX-IT KITS™

● **Adds Strength and Durability.**

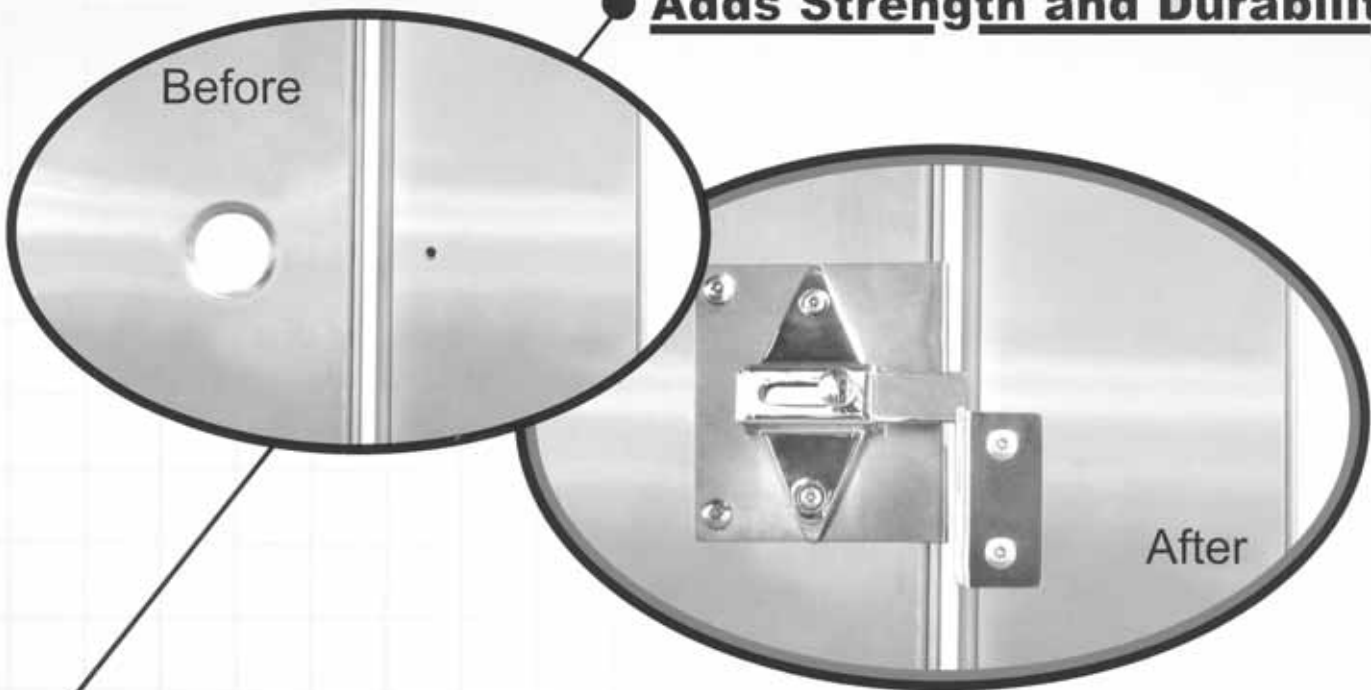

● **Each kit contains everything you need to replace broken and missing hooks or latches.**

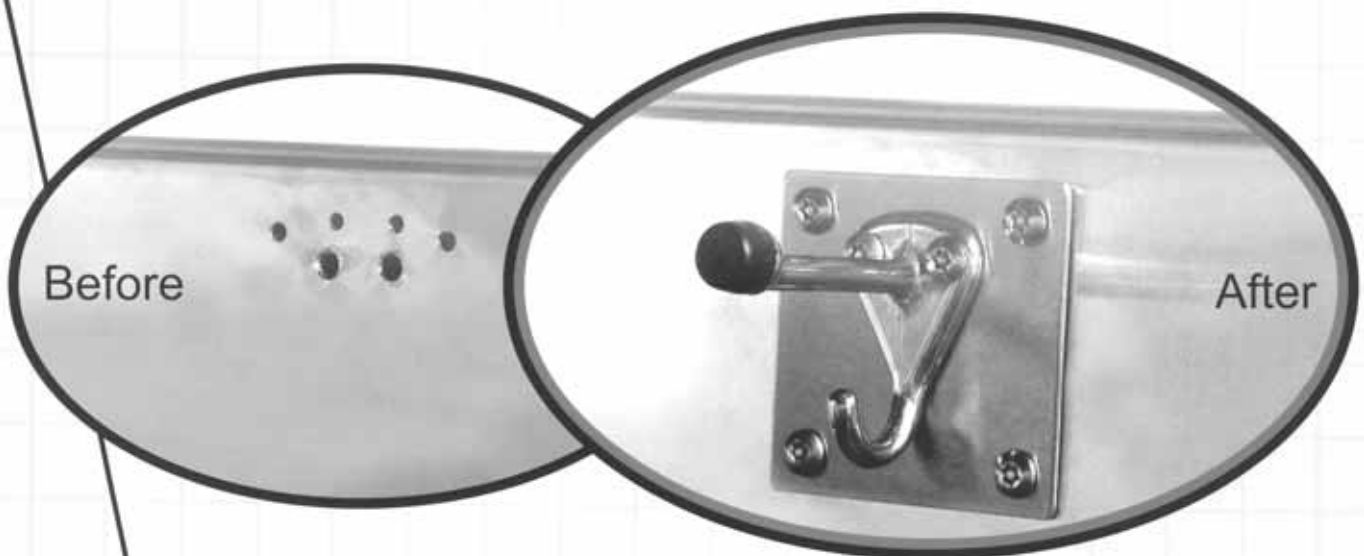

● **Stamped Stainless Plate Covers All Unsightly Holes.**

# Grab Bars

Coordinate your restroom with shower seats, curtains, corner guards and grab bars.

SPECIFY FOR ALL GRAB BARS WHEN ORDERING: 1. Part Number, 2. Concealed or exposed mounting screws  
3. 1", 1-1/4" or 1-1/2" Diameter, 4. With or without Knurling or Peening

Standard Model; 1-1/4" Tubing Diameter with Exposed Screws, without Knurling

GRAB BARS are made in Canada from type 304, 18 gauge. Stainless Steel and are 100% ADA compliant.

## Grab Bars for Toilet Stools



### STRAIGHT BARS

Part No.	Length*	Part No.	Length*
K7410	12"	K7414	32"
K7411	18"	K7415	42"
K7412	18"	K7416	36"
K7413	24"	K7417	48"



### STRAIGHT BARS WITH CENTERPOST

Part No.	Length*	Part No.	Length*
K7413C	24"	K7416C	36"
K7414C	32"	K7417C	48"
K7415C	42"		



### TOILET PARTITION BAR

Part No.	Length*	Part No.	Length*
K74181	42"	K74183	52"
K74182	48"	K74184	54"



\*CENTER LINE TO CENTER LINE

## INSTALLATION KITS

When Ordering Specify: Mounting kit desired from the table below. Kit numbers are based upon the wall construction and the flange type desired.

Order 1 kit per flange.

Wall	Round B Exposed	Part No.	D Concealed	Part No.
Wood Backing	1	(3) #10x2 SS, SMS KGB1B	(2) #10-2 SS, SMS	KGB1D
1" Toilet Partition	2	3-1/4"x16 ga. SS Plate Screws KGB2B	3"x11 ga. SS Plate Stud/Nut	KGB2D
Dry Wall	4	(3) 10-24x3 SS, MS Toggles KGB4B	(1) 3/8-16x3 ZP, MS Toggles	KGB4D
Masonry Wall	5	(3) 10-24 SS, MS Anchor KGB5B	(1) 3/8-16 ZP, MS Anchor	KGB5D

EXAMPLE:  
KIT 2B - 1" toilet partition and round exposed flange.

EXAMPLE:  
KIT 2D - 1" toilet partition and concealed flange.

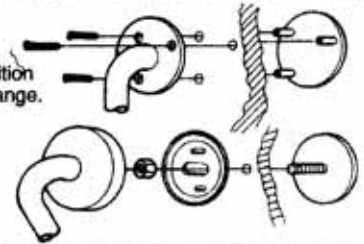

## Grab Bars For Toilet Stools



## Grab Bars For Showers

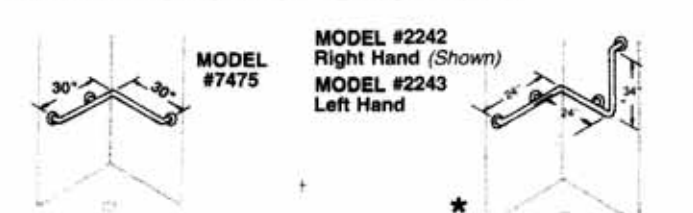

## Grab Bars For Urinals

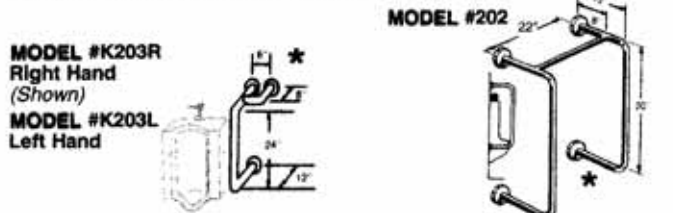





**Dispensers for paper products**  
 Roll, single fold and multifold towel  
 Control roll and hands free towel  
 Other towel dispensers

**Toilet Tissue Dispensers**  
 Interfold units  
 Roll tissue dispensers  
 Jumbo roll  
 Facial tissue, cup and table napkin

**Waste receptacles**  
 Free standing  
 Wall mounted  
 Security waste receptacles  
 ARC Series and wall mounted

**Combination dispenser / disposal fixtures**  
 Large capacity  
 Control roll and hands free  
 Medium and small capacity  
 Multi fold  
 Control roll and hands free

**Sanitary napkin vendors**  
 Napkin/tampon  
 Double vendors  
 Recessed units  
 Heavy duty

**Sanitary napkin disposal units**  
 Surface mounted  
 Recessed

**Soap Dispensers**  
 Liquid  
 Lotion  
 Tank type  
 Touch free  
 Vanity mount  
 Recessed and partition mount

**Medicine Cabinets**  
 Recessed and surface mount

**Ashtrays**  
 Surface mounted  
 Round ash urns, half moon  
 Architectural  
 Outdoor

**Mirrors**  
 Stock series, adjustable tilt and fixed tilt

**Shelves and standard signage**  
 Heavy duty, corner and flip up shelves  
 Signage, symbols

**Shower seats**

**Grab bars**

**Janitorial accessories**

**Washroom accessories**

**Hand / Hair dryers**

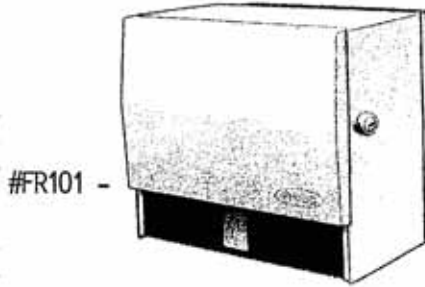

#FR101 -

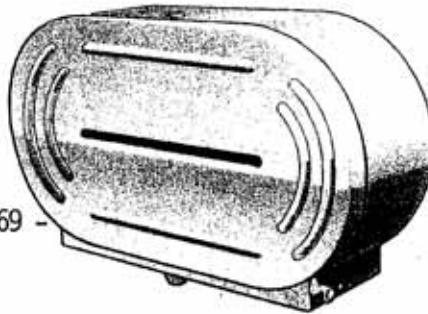

#FR169 -



#FR615-5

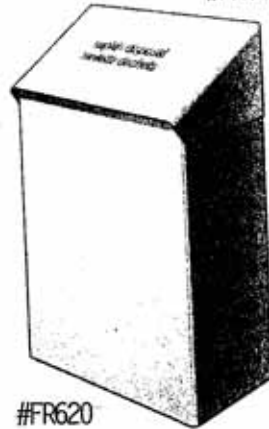

#FR620



#FR1189



#FR146 ---



#FR150 ---



#FR141-----

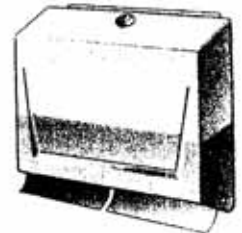

#FR143 ----

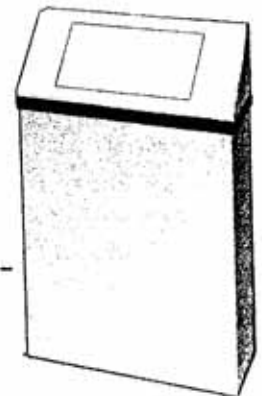

#FR304 ---

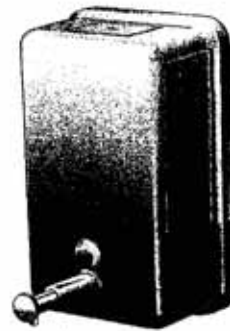

#FR708A



#FR705-100

MANY MORE PRODUCTS  
 AVAILABLE

ASK FOR PRODUCTS  
 CATALOGUE



### Safety Coat Hook

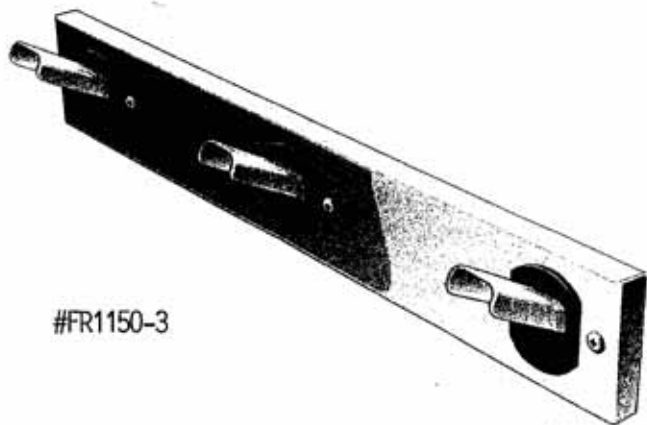

#FR1150-3

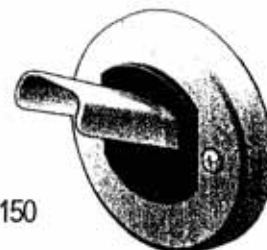
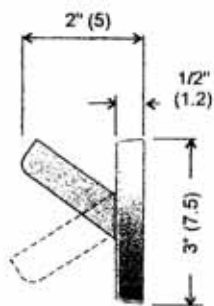

#FR1150

### Stainless Steel Hat and Coat Rack



#FR1147



#FR1146



### Stainless Steel Towel Bars

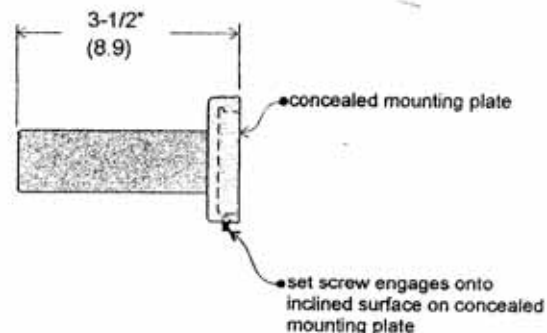
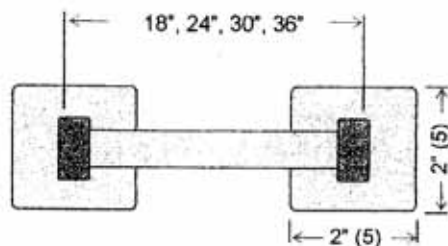
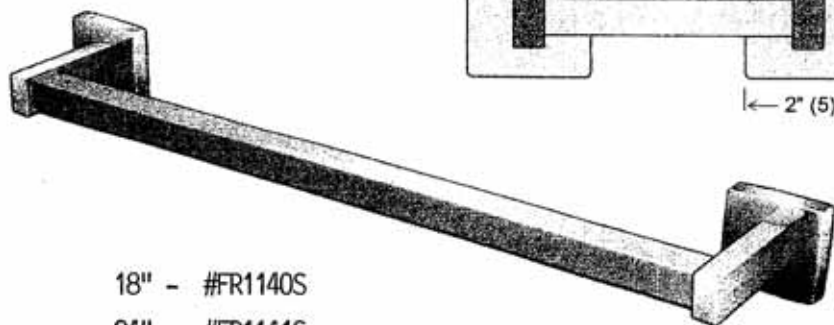

- 18" - #FR1140S
- 24" - #FR1141S
- 30" - #FR1142S
- 36" - #FR1143S

# Dome & Convex Safety Mirrors

See around corners to eliminate dangerous blind hallways and intersections.



Heavy duty mounting bracket(s) are included for easy installation in most locations.



## Circular Convex Plexiglass Mirrors

	DIAMETER	AREAS	LBS.	PART NO.
INDOOR	12"	SMALL AREA SPOT APPL.	3	KM112
	18"	UP TO 15'	5	KM118
	26"	UP TO 20'	11	KM126
HEAVY DUTY OUTDOOR	18"	UP TO 15'	5	KM218
	26"	UP TO 20'	14	KM226
	30"	UP TO 30'	16	KM230

## PLEXIGLASS 180, 360 & 90 DEGREE DOMES

Light weight and virtually unbreakable



Half-Dome

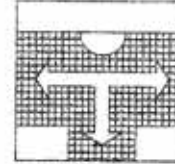

HALF 180'

Full-Dome

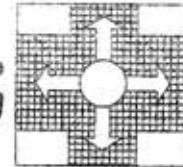

FULL 360'

Quarter-Dome

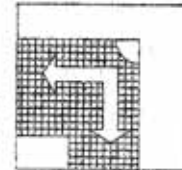

QUARTER 90'

	SIZE	DIAMETER	AREA	LBS.	PART NO.
HALF-DOME 180°	1/2	18"	UP TO 150 SQ FT	4	KM318
	1/2	26"	UP TO 200 SQ FT	7	KM326
FULL-DOME 360°	—	18"	UP TO 300 SQ FT	6	KM418
	—	26"	UP TO 400 SQ FT	10	KM426
QUARTER DOME 90°	1/4	18"	UP TO 50 SQ FT	3	KM518
	1/4	26"	UP TO 75 SQ FT	4	KM526

## SECURITY MIRROR

ADJUSTABLE TILT

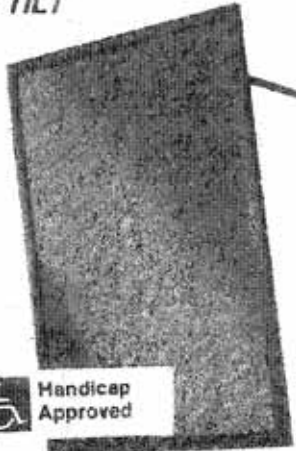

Handicap Approved

MANY SIZES  
AVAILABLE

FRAMED MIRRORS



stainless steel frame

**Automatic Door Bottoms**

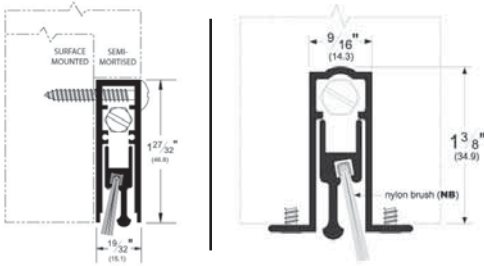

**Gasketing**

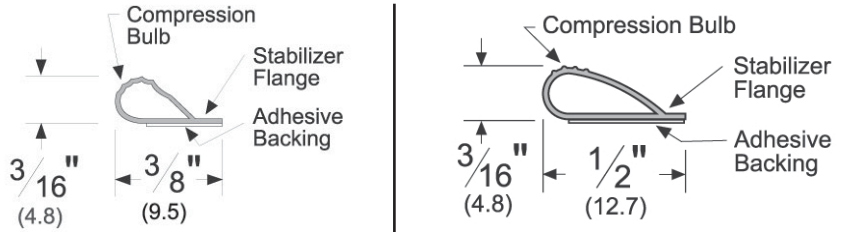

**Door Seals**

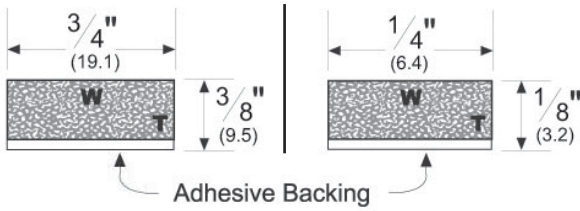

**Door Sweeps**

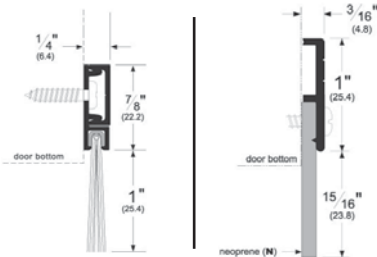

**Louver**

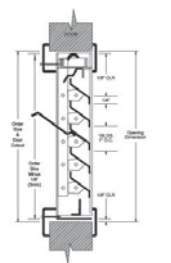

**Louver-Windstorm**

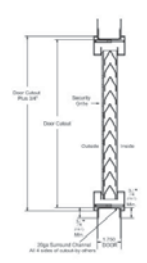

**THRESHOLDS**

MANY MORE SIZES AVAILABLE



**Saddle Threshold**



**Half Saddle/Offset Saddle**



**Thermal Barrier**



**Floor Plate Supports**



**Floor Plates & Treads**



**Interlocking Threshold**



**Threshold Caps**



**Interlocking Water Return**



**Vinyl Top Threshold**



**Special Purpose Threshold**



**Bumper Threshold For Outswing Doors**

# Door Hardware

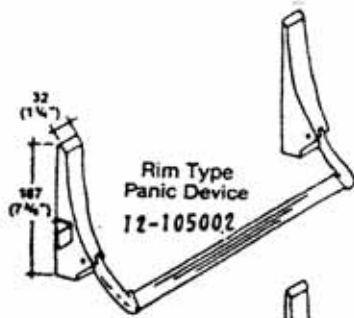

Rim Type  
Panic Device  
12-105002

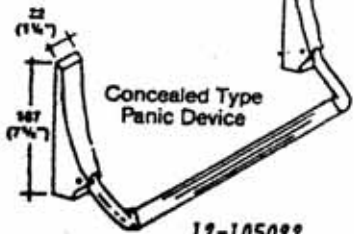

Concealed Type  
Panic Device  
12-105022

MANY MORE EXIT DEVICES AVAILABLE



Intermediate  
Offset Pivot  
12-101052

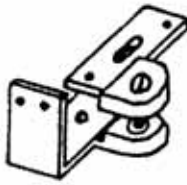

Bottom Offset  
Pivot Assembly  
12-101012

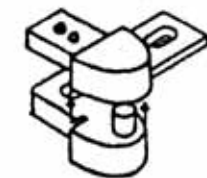

Top Offset  
Pivot Assembly  
12-101002T



Top Centre Pivot  
12-109032

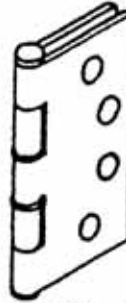

Butt Hinge  
12-100102



Bottom Pivot Door  
12-109037

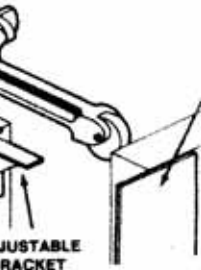

Door Coordinator  
Part No. 1836

12-107502

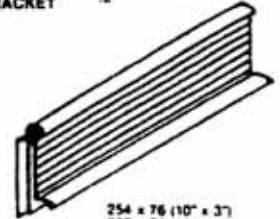

254 x 76 (10" x 3")  
330 x 76 (13" x 3")  
Letter Slots

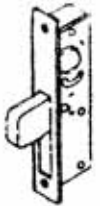

Maximum  
Security  
Type Lock  
12-102010



Cylinder for  
M.S. Lock  
12-106002

## General Accessories For Lockers

Standard Hardware Items For All Manufacturers

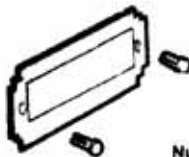

NUMBER PLATE  
Specify Locker  
Manufacturer

Specify whether  
Numbered or Blank Plate



SLOTLESS HEAD BOLT  
Size Part No.  
10-24 x 3/8" — 702343  
10-24 x 1/2" — 702713  
10-24 x 5/8" — 702737  
8-32 x 3/8" — 702434  
8-32 x 1/2" — 702831



SLOTTED HEAD BOLT  
Size Part No.  
10-24 x 1/2" — 702426  
8-32 x 1/2" — 702527



PADLOCK  
STAPLE  
Part No.  
700401



DOOR KNOB  
For 2-Person Locker  
or Box Locker  
Part No.  
700339



HEX NUT  
Size Part Nos.  
10-24 — 702550  
8-32 — 702451



KEP NUT  
Size Part Nos.  
10-24 — 702650  
8-32 — 702651



PADLOCK  
STAPLE  
Part No.  
700412



PADLOCK  
ATTACHMENT  
For Lockers where the  
Padlock Hasp is  
Missing or Damaged.  
Locking Bar Must Be  
Able to Function.  
Part Nos.

Left Hand 200195 Right Hand 200196



LOCK HOLE  
FILLER PLATE  
Part No.  
700504



NUT DRIVER  
Sizes: 3/16", 1/4", 5/16",  
11/32", 3/8", 7/16", 1/2"  
Part No.  
209075

### WALL HOOKS

#### UNIVERSAL

SINGLE PRONG  
Fits All Lockers

Part No.  
200116

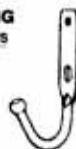

DOUBLE PRONG  
Fits All Lockers  
Part No.  
200197



DOUBLE PRONG  
CEILING HOOK  
Part No.  
701633



WALL HOOK &  
ROD SOCKET  
Part No.  
701632



DOUBLE  
PRONG  
Part No.  
701619



SINGLE  
PRONG  
Part No.  
701631



# DOOR STOPS

## RUBBER DOOR SILENCERS



For  
Metal Frames



For  
Wood Frames

## CONVEX & CONCAVE WALL MOUNTED DOOR STOP



T231



T233

## KICK DOWN DOOR HOLDERS



1060.02



1076.02



600  
Series



17



659-660



18-5

## DOME FLOOR MOUNTED DOOR STOP



T200  
LOW DOME



T218  
HIGH DOME

## FLOOR MOUNTED DOOR STOP



R470 / R471



R472 / R473

# Channel Balances

## CHANNEL STYLE BALANCES for Removable Sash Windows

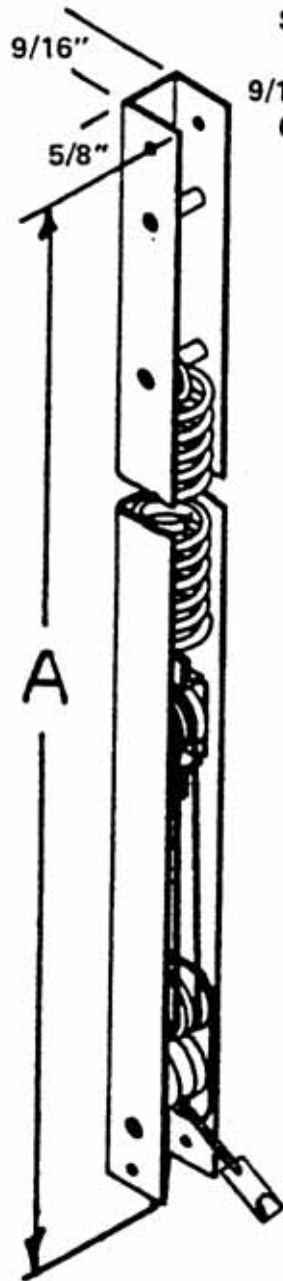

**SERIES  
C80  
9/16" x 5/8"  
Channel**

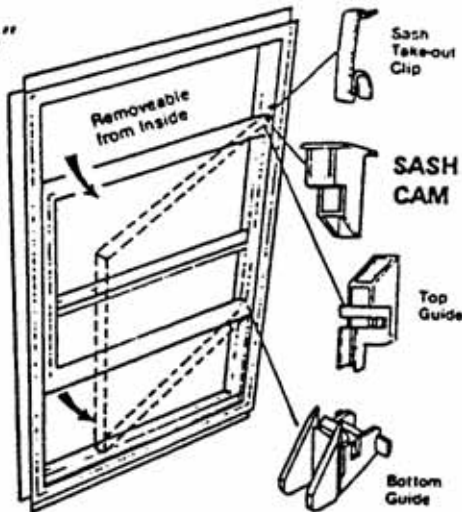

**SERIES  
CB4  
3/8" x 3/8"  
Channel**



### BOTTOM GUIDES

### TOP GUIDES



#B-1093 ST



#T-1250 ST



#WB-1093



#WT-1250



#B-1218

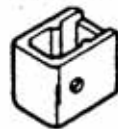

CB - 9008

### SASH CAMS

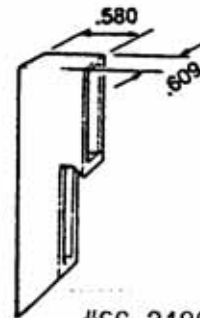

#SC-2180

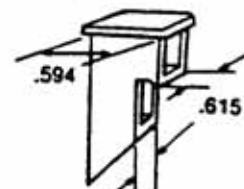

#SC-1332

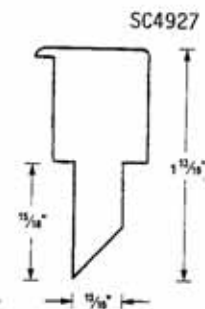

SC4927

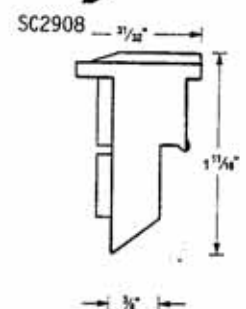

SC2908

# WINDOW HARDWARE

## 349 SERIES

When ordering specify:

- Balance type series ..... ( 349 )
- Tube length ..... ( )
- Rod length ..... ( )
- Nylon bearing color ..... ( )  
(White, Blue or Red)

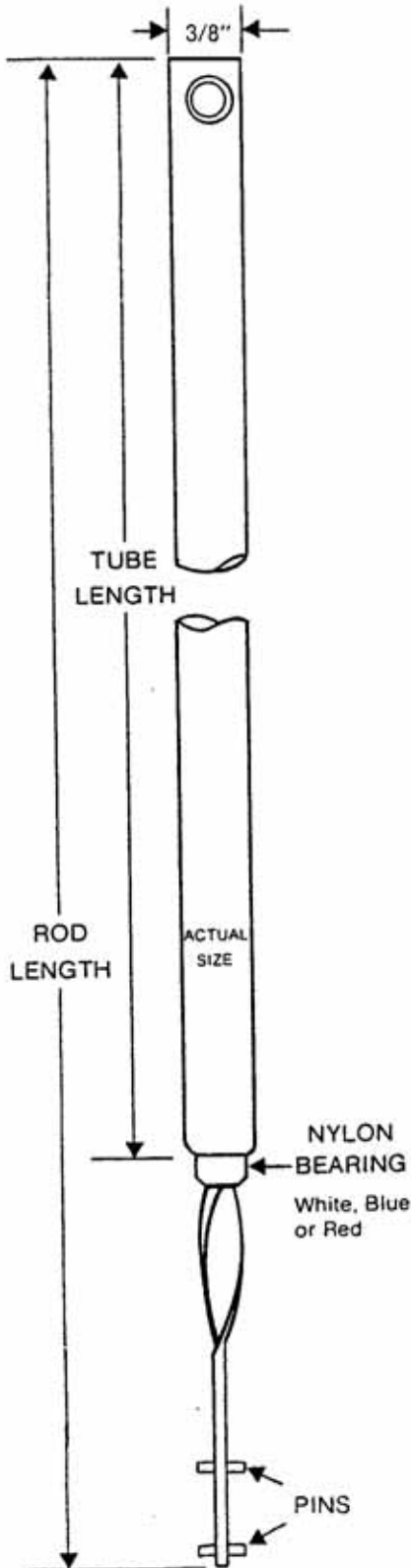

# TUBE BALANCE AND ACCESSORIES

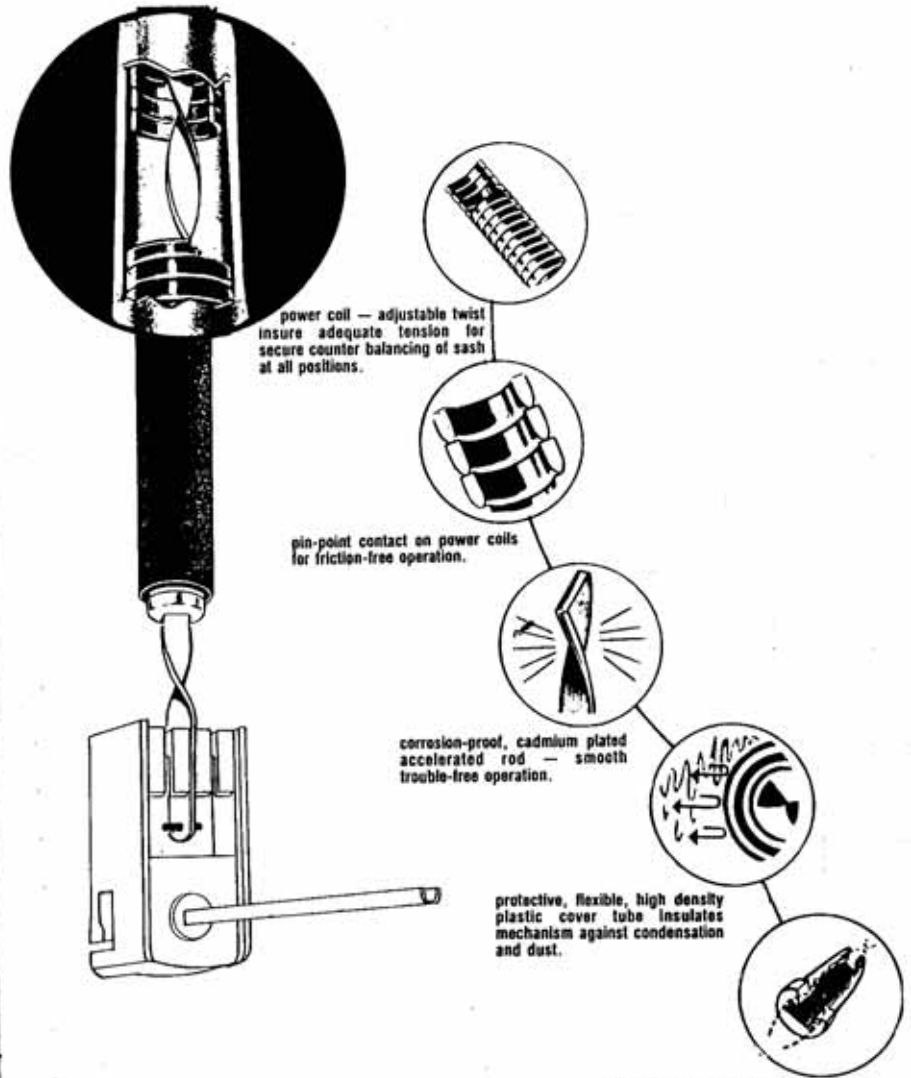

## SASH BALANCES IN THREE DIAMETERS

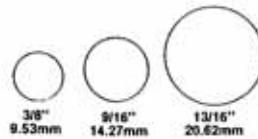

FOR WOOD, VINYL AND METAL WINDOWS

TUBING: GREY - WHITE OR TAN

AVAILABLE WITH TAKE-OUT FEET FOR REMOVABLE OR TILT WINDOWS

## SASH ATTACHMENT FOR DIFFERENT TYPE OF WINDOW

# 1000

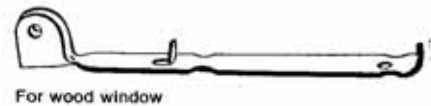

# 1000A

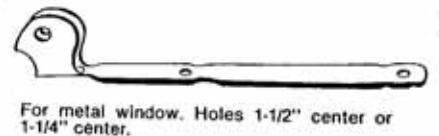



## CALDWELL TAPE BALANCES

### Overhead Style - FT

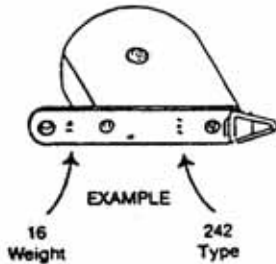

### Overhead Style - AT

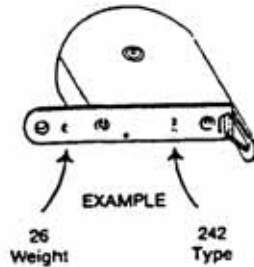

### Side Style S

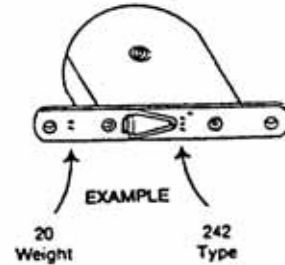

150 FT		154 FT		242 FT	
LBS.	#	LBS.	#	LBS.	#
4-6	7124	20-24	7150	4-6	7220
7-8	7125	25-28	7151	8	7221
9-10	7126	29-32	7152	10	7222
11-12	7127	33-36	7153	12	7223
14	7128	37-41	7154	13-14	7224
16	7129	42-46	7155	15-16	7225
17	7130	47-50	7156	18	7226
21	7131			20	7227
23	7132			22	7228
25-27	7133			23-24	7229
30	7134			25-26	7230
31-35	7135				

150 AT		154 AT		242 AT	
LBS.	#	LBS.	#	LBS.	#
8	7112	20-24	7143	4-6	7210
8	7113	25-28	7144	7-8	7211
10	7114	29-32	7145	9-10	7212
12	7115	33-36	7146	11-12	7213
14	7116	41	7147	13-14	7214
15-16	7117	44	7148	15-16	7215
17-18	7118	47-50	7149	17-18	7216
19-20	7119			19-20	7217
21-24	7120			21-23	7218
25-27	7121			24-26	7219
28-30	7122				
31-35	7123				

150 S		154 S		242 S	
LBS.	#	LBS.	#	LBS.	#
4-6	7100	20-24	7136	6	7200
7-8	7101	25-28	7137	7-8	7201
9-10	7102	29-32	7138	9-10	7202
11-12	7103	33-36	7139	11-12	7203
13-14	7104	37-41	7140	13-14	7204
15-16	7105	44	7141	15-16	7205
17-18	7106	47-50	7142	18	7206
19-20	7107			19-20	7207
21-24	7108			21-23	7208
25-27	7109			24-26	7209
28-30	7110				
31-35	7111				

### HOW TO ORDER:

1. Identify style by above drawings: FT, AT or S.
2. Identify type (type number will be stamped on the face plate). In some cases you may need to scrape off paint or dirt to locate.)
3. Identify weight (weight number will be stamped on the face plate).
4. After all above steps have been identified, refer to appropriate chart above to find PART NUMBER.

**NOTE:** 150 types are adjustable 3 lbs. plus or minus weights shown.

Type 150 Maximum Sash Weight: 35 lbs. Tape Length: 50"

Type 154 Maximum Sash Weight: 50 lbs. Tape Length: 50"

Type 242 Maximum Sash Weight: 26 lbs. Tape Length: 39"

Other Caldwell sash balances, not described on this page, have been developed for specific purposes, special windows or other devices and can be special ordered. Please send samples or data to our Research Department.

**BE POSITIVE — SEND A SAMPLE**

# Window Hardware

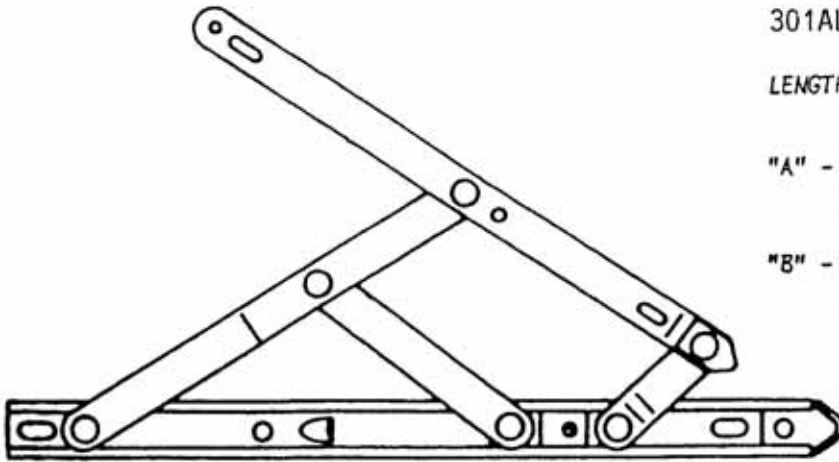

4 - BAR HINGE

301AL & 201AL SERIES

LENGTH - 8". 10". 12". 14". 16". 18". 20". 24".

"A" - HEAVY DUTY, WIDTH 7/8"  
HEIGHT OR THICKNESS 5/8"

"B" - STANDARD, WIDTH 11/16"  
HEIGHT OR THICKNESS 7/16"

Many Sizes Available and Look Alike...  
**PLEASE SEND A SAMPLE**

## Typical Casement Window

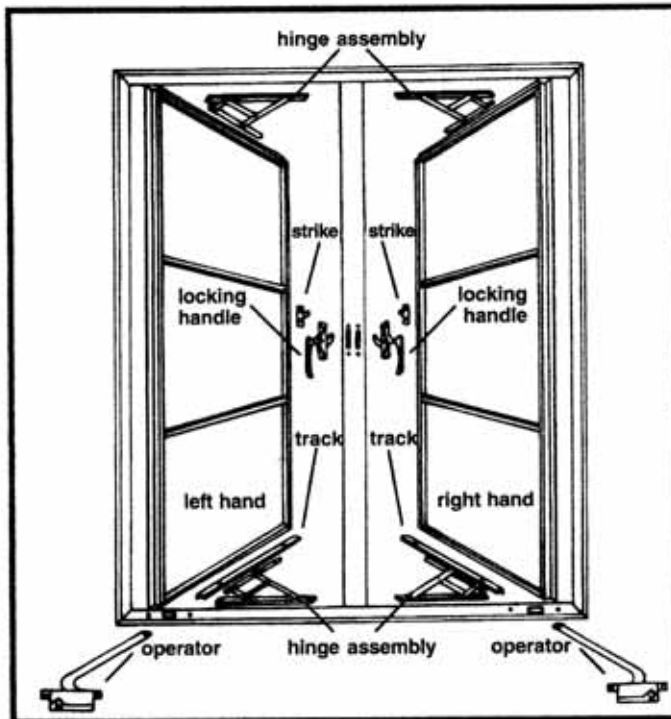

We currently have window handles in stock from the following manufactures:

**Truscon • Fenestra • Kawneer • Ceco  
Lupton • Bayley • Sampson  
Anderberg • Cupples  
Truth • Ives • Kaiser • Hope • Bailey**

*Specializing in.....*

**REPLACEMENT  
WINDOW  
HARDWARE  
for  
ALL WINDOW  
MANUFACTURERS**

visit

[www.replacementhardware.ca](http://www.replacementhardware.ca)

- single & two hole cam handles
- project and angle base handles
- four hole & casement handles
- sweep locks

# PUSH BARS

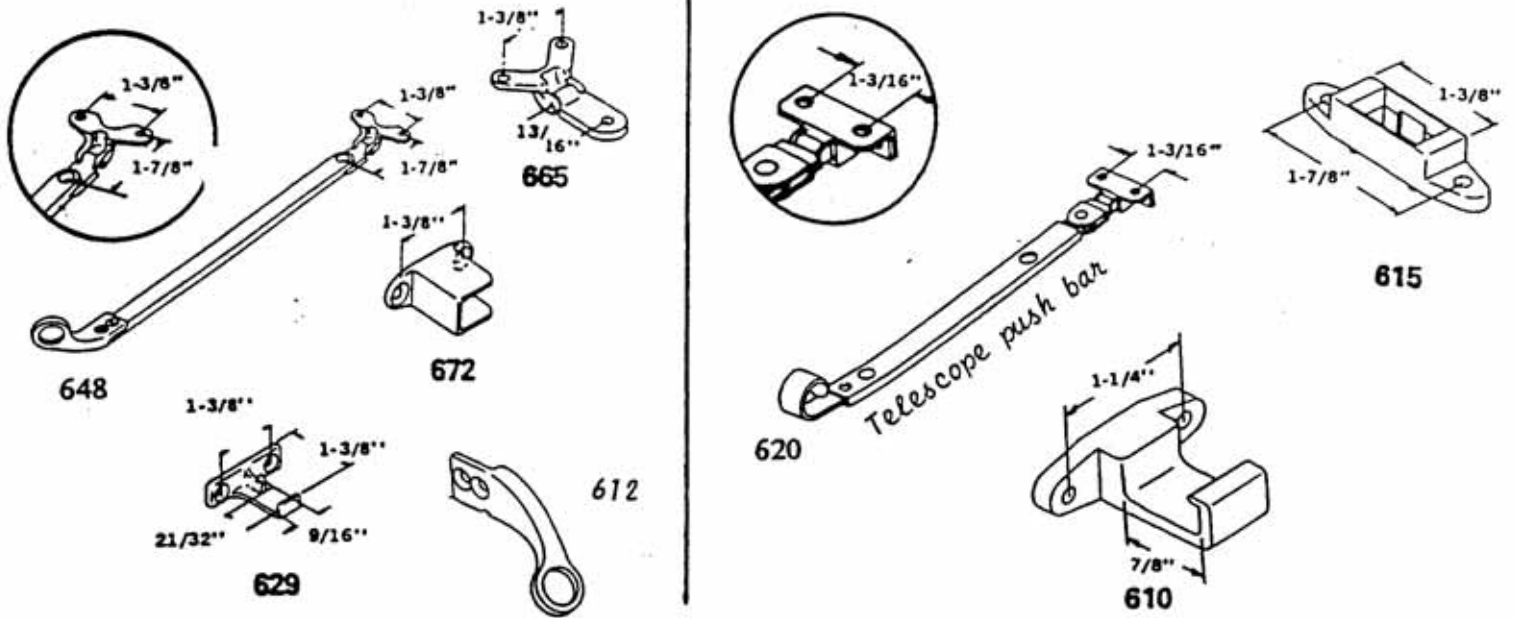

BAR LENGTH - 10-12-14-16-18-20"

**WHEN IN DOUBT — SEND A SAMPLE!**

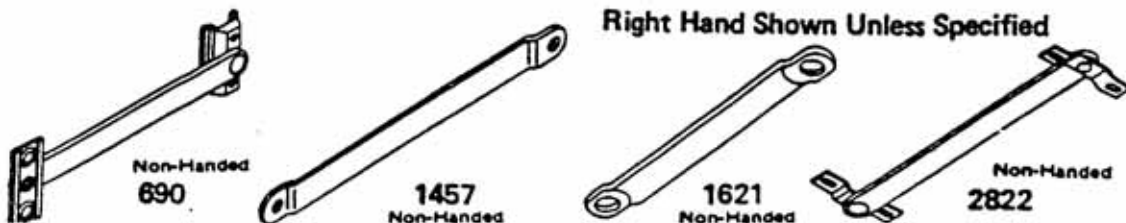
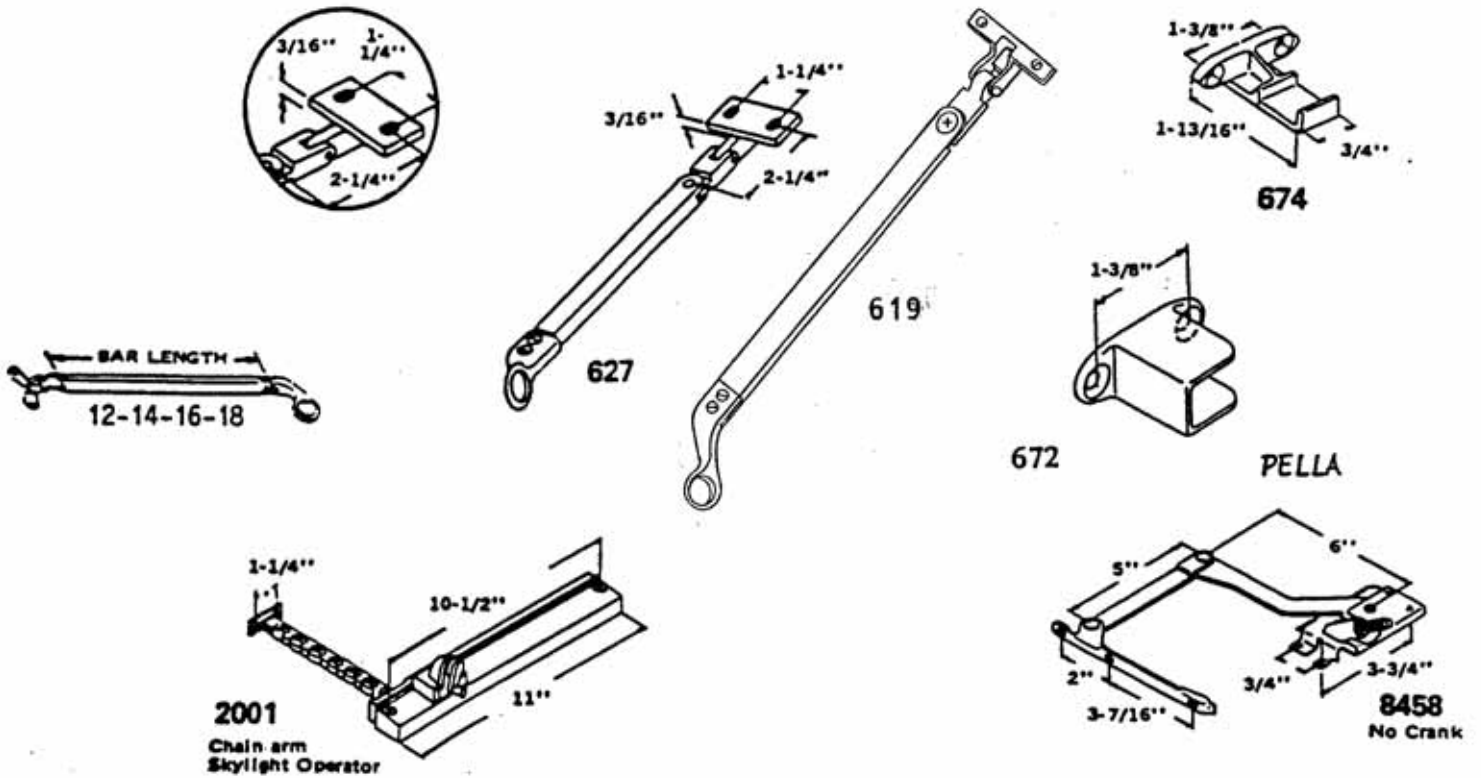

# Window Hardware

## Roto Operator Assemblies

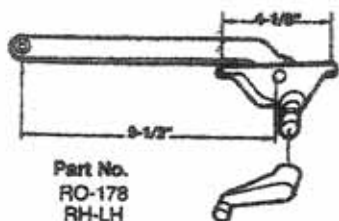

Part No.  
RO-178  
RH-LH  
RH Shown

Part No.  
See Below  
RH Shown

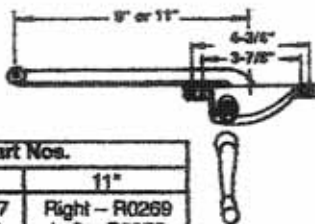

Part Nos.	
9"	11"
Right - R0267	Right - R0269
Left - R0268	Left - R0270

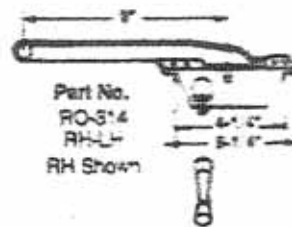

Part No.  
RO-314  
RH-LH  
RH Shown

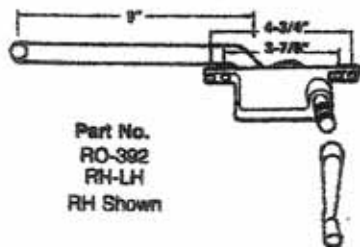

Part No.  
RO-392  
RH-LH  
RH Shown

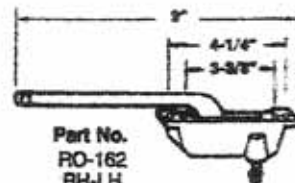

Part No.  
RO-162  
RH-LH  
RH Shown

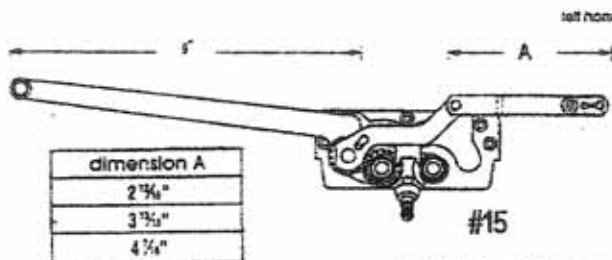

SINGLE ARM OPERATOR  
LH SHOWN

Part No.	Arm Length
RO1531	9-1/2"
RO1532	13-1/2"

TRUTH

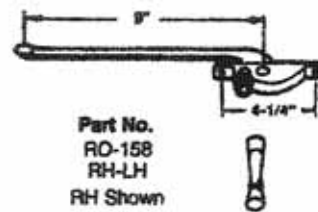

Part No.  
RO-158  
RH-LH  
RH Shown

TRUTH ENTRY GARD

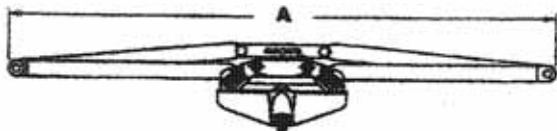

ROTO GEAR AWNING  
(Single Pull)

Part No.	"A"
RO1110	20-1/2"
RO1112	16-1/4"

TRUTH

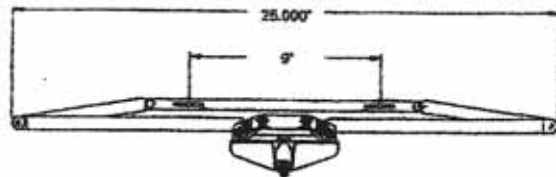

ROTO GEAR AWNING  
(Dual Pull)  
Part No.  
RO1114  
TRUTH

#336-18G ALSO AVAILABLE 13.125" OVERALL



ROTO GEAR AWNING  
w/ Guide Bar (not shown)

Part No.  
RO1118  
TRUTH

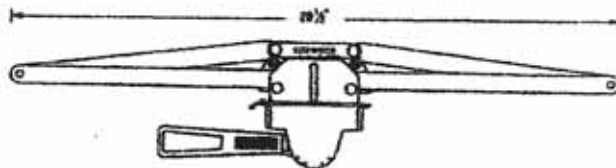

Lever lock #336-18G  
TRUTH

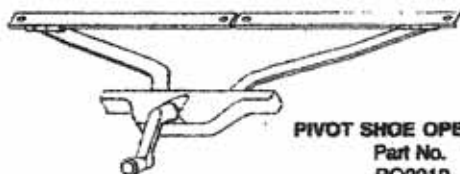

PIVOT SHOE OPERATOR  
Part No.  
RO2210  
TRUTH

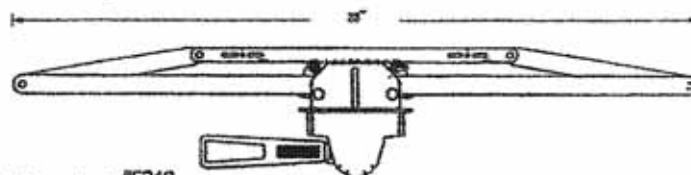

Dual pull lever lock #5310  
TRUTH

TRUTH HARDWARE  
#R01532E

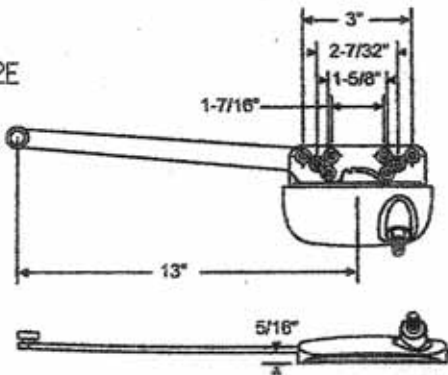

TRUTH HARDWARE  
#R01531E

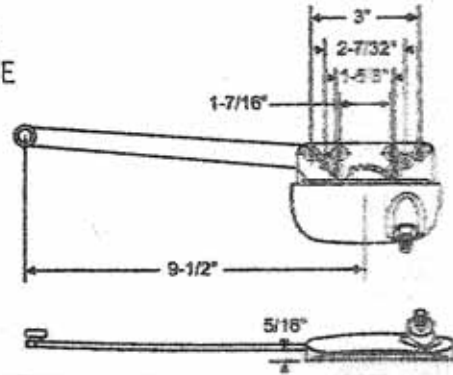

## Maxim® Dual Arm Operator

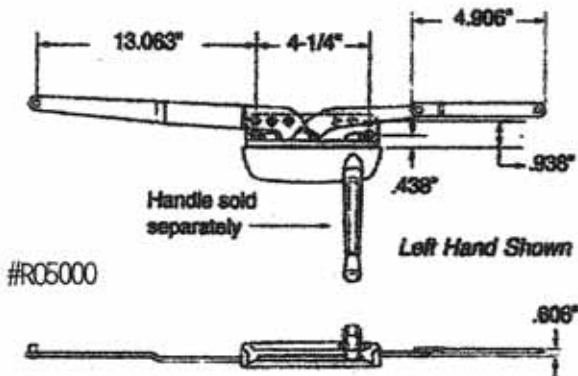

## Maxim® Dyad Operator

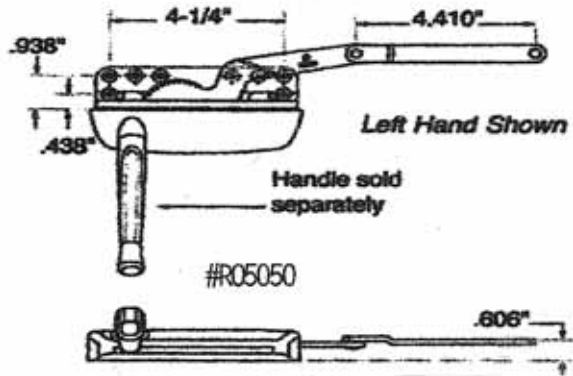

## ENCORE™ DUAL ARM OPERATOR (SILL MOUNT)

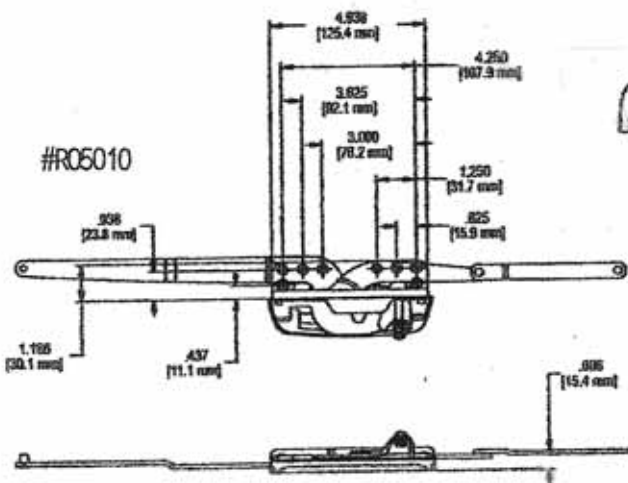

## ENCORE™ SINGLE ARM OPERATORS (SILL MOUNT)

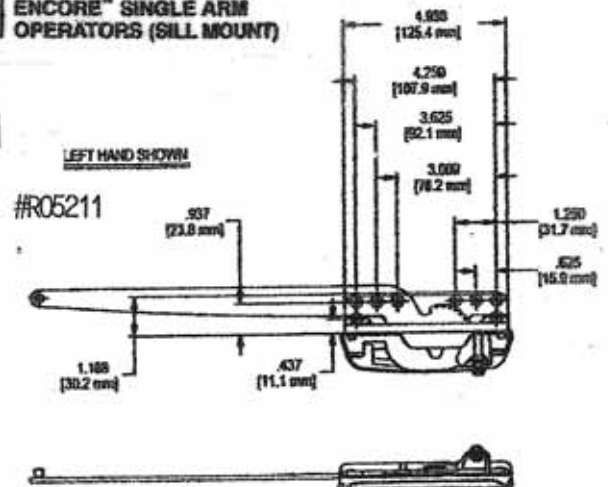

TELESCOPING  
PUSH BAR OPERATORS

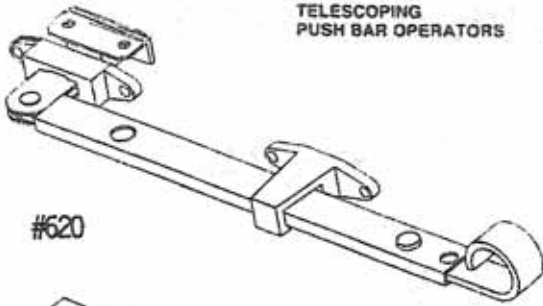

#620

SINGLE ARM  
OPERATOR (FACE-MOUNT)

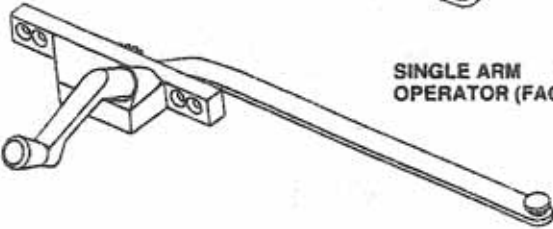

#RO-241  
LH-RH  
9" or 11" arm

ENTRYGARD™II  
CAM LOCK



#17

SASH LOCK



#2022

POLE-OPERATED  
CAM HANDLE  
WITH CONCEALED PAWL  
#27 / OFFSET BASE

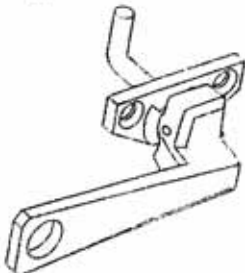

TRIMLINE™  
CAM HANDLE LOCKS

#25

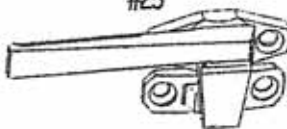

ENTRYGARD™  
DUAL ARM OPERATOR  
DIFFERENT SIZES AVAILABLE  
#15

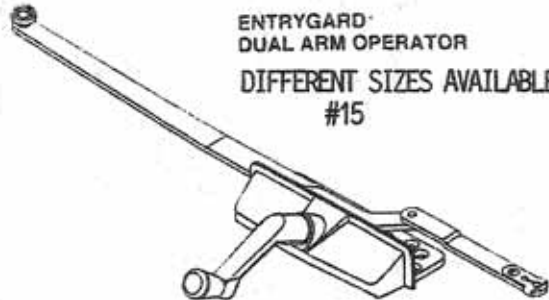

DYAD OPERATOR

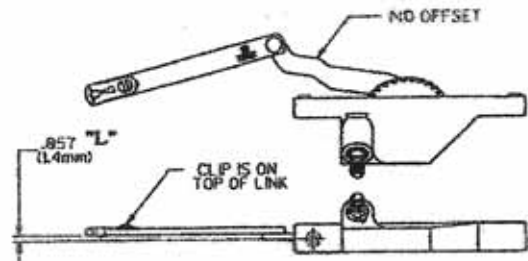

#R02333

AWNING HINGES  
#13 MANY SIZES  
AVAILABLE

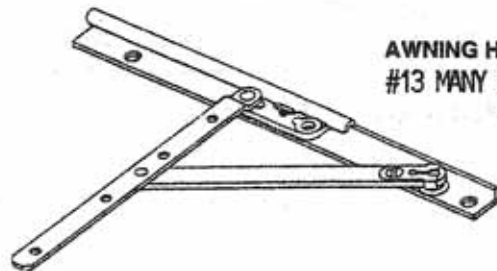

Limit Device/  
Friction Adjuster

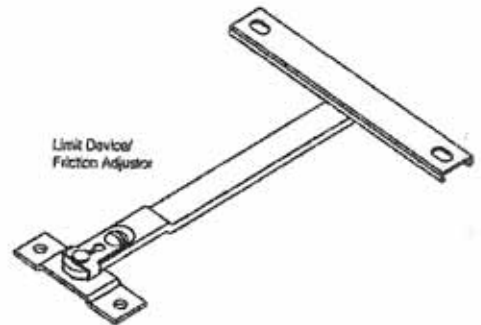

LIMIT DEVICE

99-20-00-001

OTHER PARTS & ACCESSORIES AVAILABLE  
Please Call, Write or Fax for information.

# Window Hardware

## 1-1/4" Hole Spacing

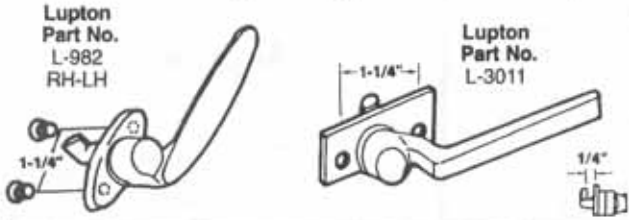

## Project-In Handles

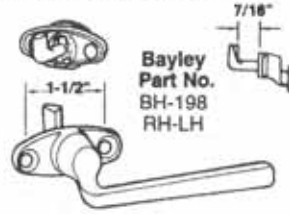

## 1-1/2" Hole Spacing

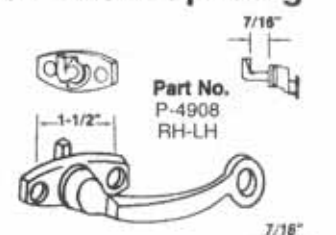

## 1-3/8" Hole Spacing

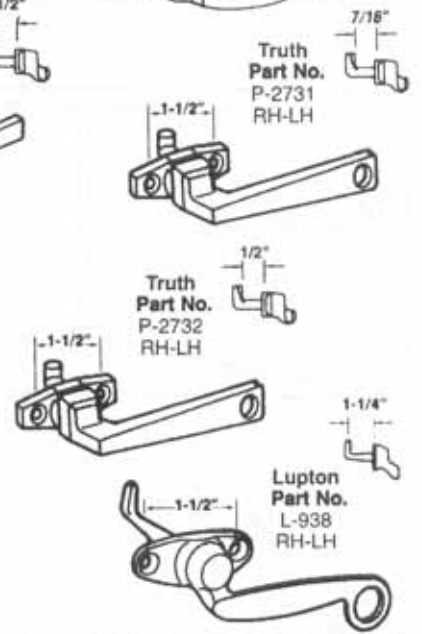
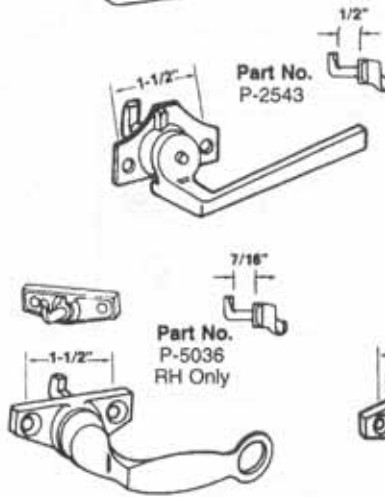
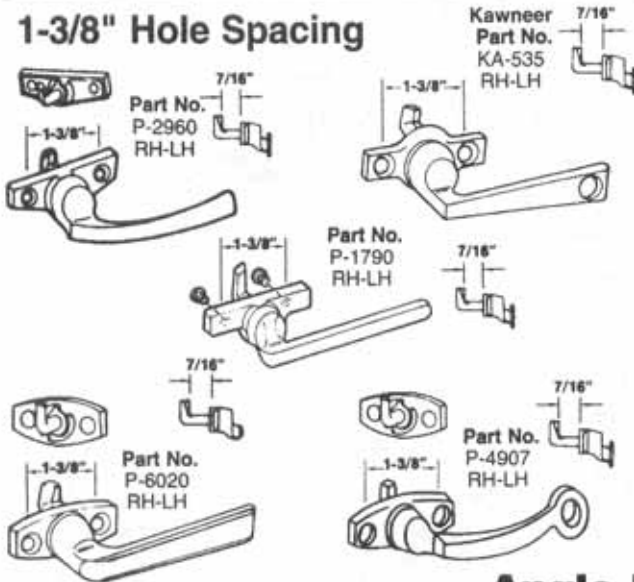

## Angle Base Handles

### 1-1/8" Hole Spacing



### 1-1/4" Hole Spacing

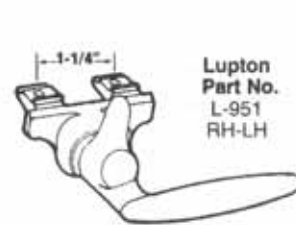

## 1-3/8" Hole Spacing

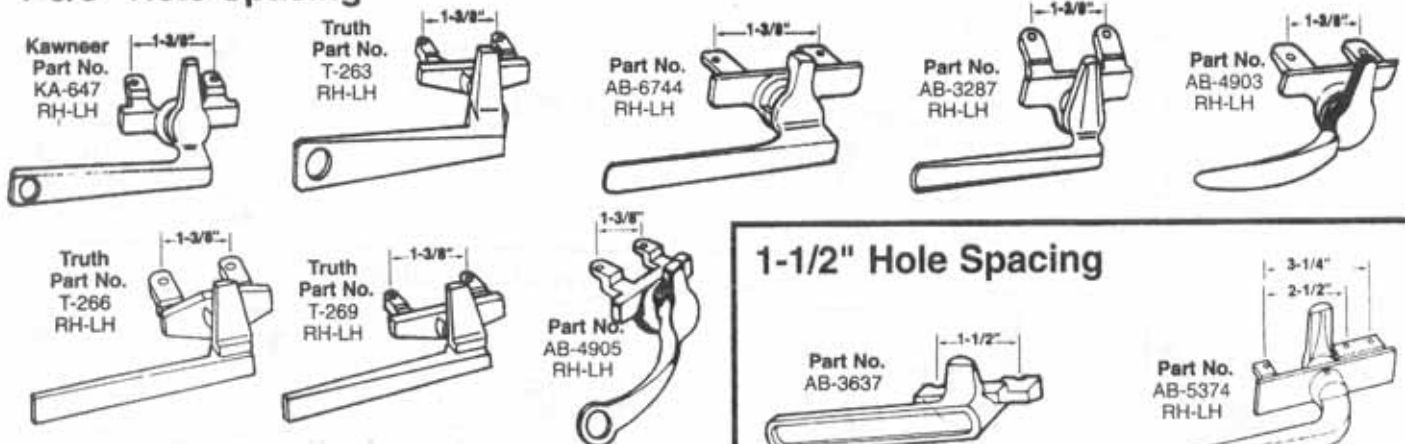

### 1-1/2" Hole Spacing

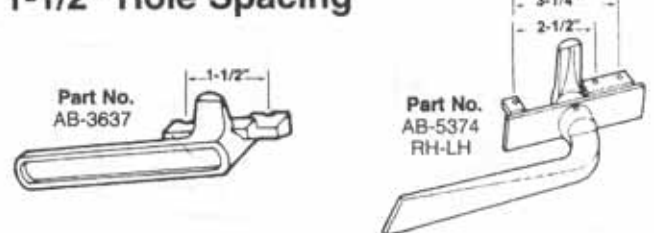

# Window Hardware

## 1-1/4" Hole Spacing



Part No.  
T-MR 128

## Two Hole Cam Handles

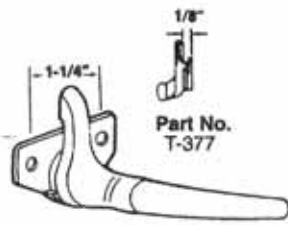

Part No.  
T-377

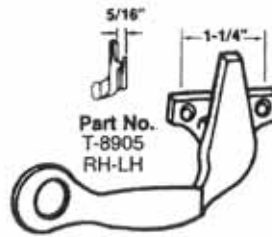

Part No.  
T-8905  
RH-LH

## 1-3/8" Hole Spacing

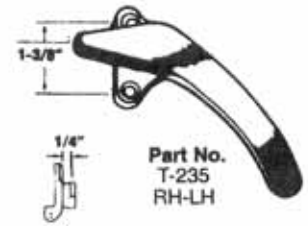

Part No.  
T-235  
RH-LH

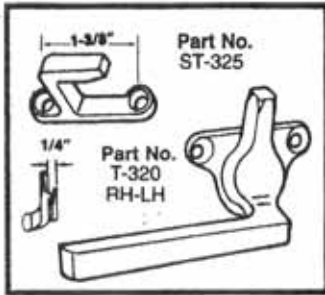

Part No.  
ST-325

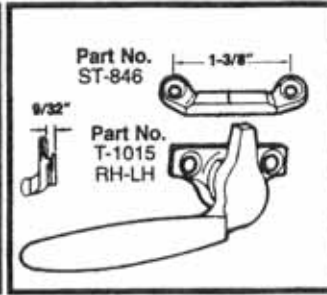

Part No.  
ST-846

Part No.  
T-1015  
RH-LH

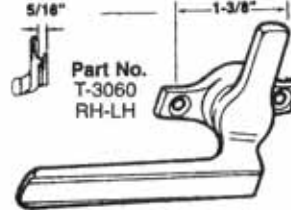

Part No.  
T-3060  
RH-LH

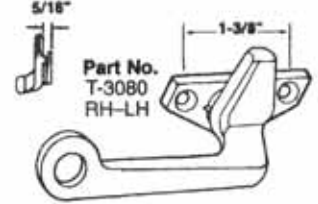

Part No.  
T-3080  
RH-LH



Part No.  
T-6105  
RH-LH



Part No.  
T-7725



Part No.  
T-6527

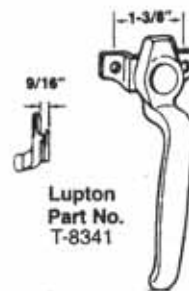

Lupton  
Part No.  
T-8341

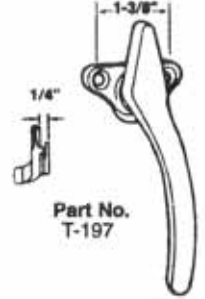

Part No.  
T-197

## 1-1/2" Hole Spacing

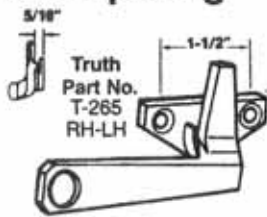

Truth  
Part No.  
T-265  
RH-LH

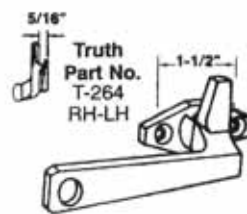

Truth  
Part No.  
T-264  
RH-LH

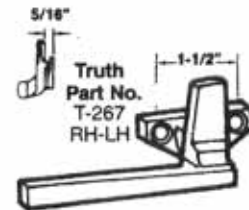

Truth  
Part No.  
T-267  
RH-LH

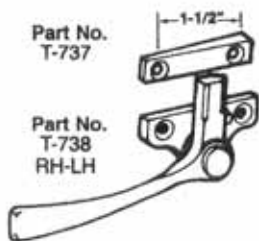

Part No.  
T-737

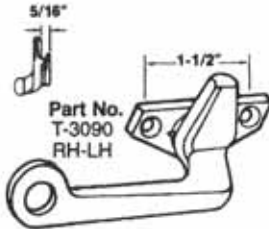

Part No.  
T-3090  
RH-LH

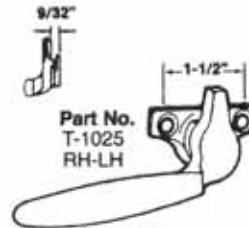

Part No.  
T-1025  
RH-LH

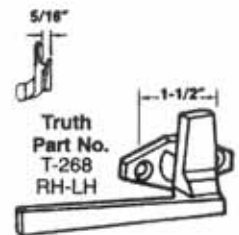

Truth  
Part No.  
T-268  
RH-LH

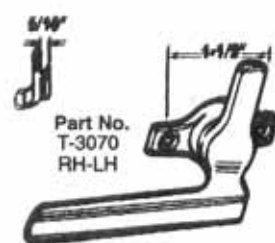

Part No.  
T-3070  
RH-LH

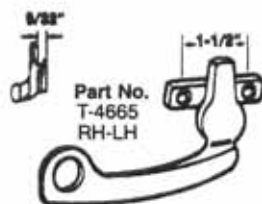

Part No.  
T-4665  
RH-LH

## 1-5/8" Hole Spacing

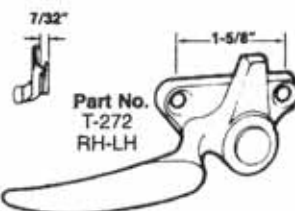

Part No.  
T-272  
RH-LH

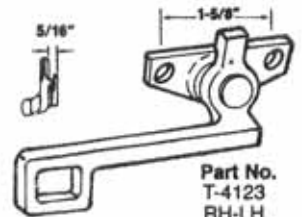

Part No.  
T-4123  
RH-LH

WINDOW  
HARDWARE





**ASK US ABOUT OUR  
EXTENSIVE LINE OF CASTERS**





# ASK US ABOUT OUR EXTENSIVE LINE OF GLIDES





SINCE 1981  
**WIELHOUWER**

**REPLACEMENT HARDWARE SPECIALISTS**

---

Supplier of Aftermarket Parts to Public and Private Facilities

**1-800-465-2815**

Email: [info@replacementhardware.ca](mailto:info@replacementhardware.ca)

Website: [www.replacementhardware.ca](http://www.replacementhardware.ca)

Phone: (519) 633-0998 • Fax: (519) 631-2282